

HNV

Standard couplings for industrial applications, ISO 7241-B interchange.

Standard couplings for industrial applications. Complete range of sizes from 1/8" to 2" (with BSP, NPT and SAE female threads available). ISO 7241-1 part B interchange.



Applications

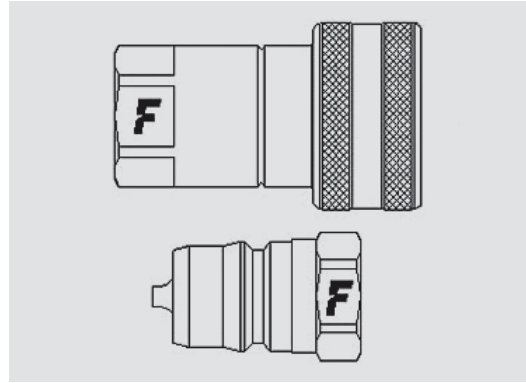

Technical Specifications

dash	Size mm	inch	Working Pressure (MPa)	Flow Rate (l/min)	Spillage (ml)	Force to Connect (N)	Burst pressure (MPa)		
							Male	Female	Male + Female
02	3,2	1/8"	50	5	0,5	60	280	200	200
04	6,3	1/4"	45	17	1	65	180	200	180
06	10	3/8"	30	50	1,5	85	130	120	180
08	12,5	1/2"	35	75	2,8	97	140	140	150
12	20	3/4"	25	190	10	120	110	100	100
16	25	1"	30	270	13	180	120	120	120
24	37,5	1-1/2"	14	750	80	185	56	56	60
32	50	2"	9	1600	160	160	38	40	45

Material	Steel
Seals	NBR
Working temperatures	- 25 °C to + 125 °C
Surface treatment	MATE 500 (CrIII)
Series Interchange	ISO 7241-B
Valve Type	Poppet
Connection	Sleeve Retraction
Disconnection	Sleeve Retraction
Connection Under Pressure	Not Allowed

Pressure Drop

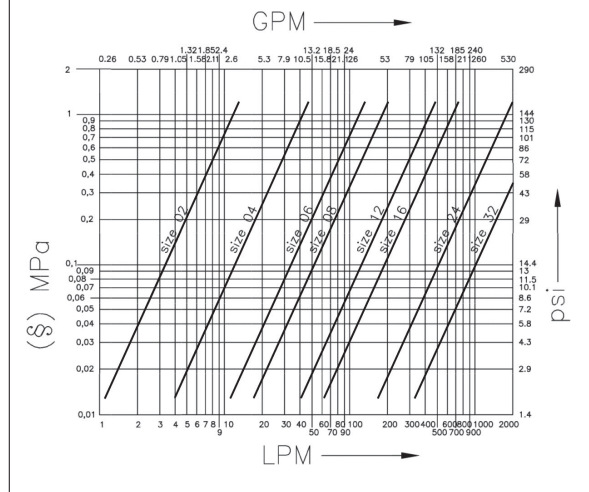

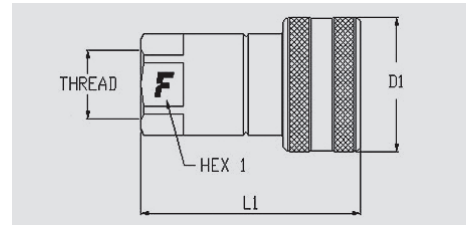

Size		Thread details			FEMALE						
inch	mm	Thread Type	Standard	Thread	Part Number	L (L1 + Thread)		D1		HEX1	
						mm	inch	mm	inch	mm	inch
1/8"	3,2	F BSPP	ISO 1179-1	BSPP 1/8 FEMALE	HNV 18 GAS F	50,3	1,98	23	0,91	18	0,71
1/8"	3,2	F NPTF	ANSI B1.20.3	NPTF 1/8 FEMALE	HNV 18 NPT F	50,3	1,98	23	0,91	18	0,71
1/4"	6,3	O/ SAE	ISO 11926-1	9/16"-18 UNF FEMALE ORB	HNV 14-38SAE F	60	2,36	28	1,1	19	0,75
1/4"	6,3	F BSPP	ISO 1179-1	BSPP 1/4 FEMALE	HNV 14 GAS F	56	2,2	28	1,1	19	0,75
1/4"	6,3	F NPTF	ANSI B1.20.3	NPTF 1/4 FEMALE	HNV 14 NPT F	56	2,2	28	1,1	19	0,75
3/8"	10	O/ SAE	ISO 11926-1	9/16"-18 UNF FEMALE ORB	HNV 38-38SAE F	64	2,52	35	1,38	24	0,94
3/8"	10	F BSPP	ISO 1179-1	BSPP 3/8 FEMALE	HNV 38 GAS F	64	2,52	35	1,38	24	0,94
3/8"	10	F NPTF	ANSI B1.20.3	NPTF 3/8 FEMALE	HNV 38 NPT F	64	2,52	35	1,38	24	0,94
3/8"	10	F NPTF	ANSI B1.20.3	NPTF 3/8 FEMALE	HNV 38 NPT F N	64	2,52	35	1,38	24	0,94
1/2"	12,5	O/ SAE	ISO 11926-1	7/8"-14 UNF FEMALE ORB	HNV 12-58SAE F	71,5	2,81	44	1,73	30	1,18
1/2"	12,5	F BSPP	ISO 1179-1	BSPP 1/2 FEMALE	HNV 12 GAS F	71,5	2,81	44	1,73	30	1,18
1/2"	12,5	F BSPP	ISO 1179-1	BSPP 1/2 FEMALE	HNV 12 GAS F V	71,5	2,81	44	1,73	30	1,18
1/2"	12,5	F NPTF	ANSI B1.20.3	NPTF 1/2 FEMALE	HNV 12 NPT F	71,5	2,81	44	1,73	30	1,18
3/4"	20	O/ SAE	ISO 11926-1	1-1/16"-12 UN FEMALE ORB	HNV 34-34SAE F	89	3,5	52	2,05	36	1,42
3/4"	20	12/ SAE	ISO 8434-3	1-3/16"-12 UN MALE BULKHEAD ORFS	HNV 34-12/34SF	146	5,75	52	2,05	36	1,42
3/4"	20	F BSPP	ISO 1179-1	BSPP 3/4 FEMALE	HNV 34 GAS F	89	3,5	52	2,05	36	1,42
3/4"	20	F NPTF	ANSI B1.20.3	NPTF 3/4 FEMALE	HNV 34 NPT F	89	3,5	52	2,05	36	1,42
1"	25	O/ SAE	ISO 11926-1	1-5/16"-12 UN FEMALE ORB	HNV 1- 15AE F	106	4,17	62	2,44	41	1,61
1"	25	F BSPP	ISO 1179-1	BSPP 1 FEMALE	HNV 1 GAS F	106	4,17	62	2,44	41	1,61
1"	25	F NPTF	ANSI B1.20.3	NPTF 1 FEMALE	HNV 1 NPT F	106	4,17	62	2,44	41	1,61
1-1/2"	37,5	F BSPP	ISO 1179-1	BSPP 1-1/2 FEMALE	HNV112 GAS F	126,4	4,98	75	2,95	65	2,56
1-1/2"	37,5	F BSPP	ISO 1179-1	BSPP 1-1/4 FEMALE	HNV112-114GAS F	126	4,96	75	2,95	65	2,56
2"	50	F NPTF	ANSI B1.20.3	NPTF 2 FEMALE	HNV 2 NPT F	142	5,59	105	4,13	89	3,5

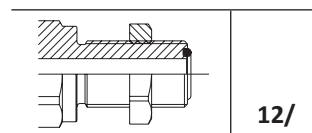
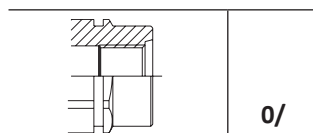
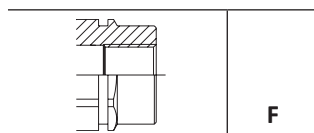

HNV

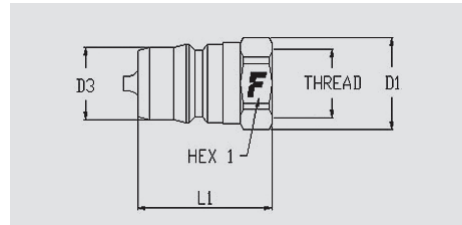

Size		Thread details			MALE									
inch	mm	Thread Type	Standard	Thread	Part Number	L (L1 + Thread)		D1		D3		HEX1		
						mm	inch	mm	inch	mm	inch	mm	inch	
1/8"	3,2	F BSPP	ISO 1179-1	BSPP 1/8 FEMALE	HNV 18 GAS M	31,5	1,24	18,5	0,73	10,8	0,43	17	0,67	
1/8"	3,2	F NPTF	ANSI B1.20.3	NPTF 1/8 FEMALE	HNV 18 NPT M	31,5	1,24	19	0,75	10,8	0,43	17	0,67	
1/4"	6,3	O/ SAE	ISO 11926-1	9/16"-18 UNF FEMALE ORB	HNV 14-38SAE M	39	1,54	21	0,83	14,1	0,56	19	0,75	
1/4"	6,3	F BSPP	ISO 1179-1	BSPP 1/4 FEMALE	HNV 14 GAS M	35	1,38	21	0,83	14,1	0,56	19	0,75	
1/4"	6,3	F NPTF	ANSI B1.20.3	NPTF 1/4 FEMALE	HNV 14 NPT M	35	1,38	21	0,83	14,1	0,56	19	0,75	
3/8"	10	O/ SAE	ISO 11926-1	3/4"-16 UNF FEMALE ORB	HNV 38-12SAE M	45	1,77	30	1,18	19	0,75	27	1,06	
3/8"	10	O/ SAE	ISO 11926-1	9/16"-18 UNF FEMALE ORB	HNV 38-38SAE M	39	1,54	24,5	0,96	19	0,75	22	0,87	
3/8"	10	F BSPP	ISO 1179-1	BSPP 3/8 FEMALE	HNV 38 GAS M	39	1,54	24,5	0,96	19	0,75	22	0,87	
3/8"	10	F NPTF	ANSI B1.20.3	NPTF 3/8 FEMALE	HNV 38 NPT M	39	1,54	24,5	0,96	19	0,75	22	0,87	
3/8"	10	F NPTF	ANSI B1.20.3	NPTF 3/8 FEMALE	HNV 38 NPT M N	39	1,54	24,5	0,96	19	0,75	22	0,87	
1/2"	12,5	O/ SAE	ISO 11926-1	3/4"-16 UNF FEMALE ORB	HNV 12-12SAE M	44	1,73	30	1,18	23,5	0,93	27	1,06	
1/2"	12,5	O/ SAE	ISO 11926-1	7/8"-14 UNF FEMALE ORB	HNV 12-58SAE M	50	1,97	33	1,3	23,5	0,93	30	1,18	
1/2"	12,5	F BSPP	ISO 1179-1	BSPP 1/2 FEMALE	HNV 12 GAS M	44	1,73	30	1,18	23,5	0,93	27	1,06	
1/2"	12,5	F NPTF	ANSI B1.20.3	NPTF 1/2 FEMALE	HNV 12 NPT M	44	1,73	30	1,18	23,5	0,93	27	1,06	
3/4"	20	O/ SAE	ISO 11926-1	1-1/16"-12 UN FEMALE ORB	HNV 34-34SAE M	55	2,17	38	1,5	31,5	1,24	34	1,34	
3/4"	20	F BSPP	ISO 1179-1	BSPP 3/4 FEMALE	HNV 34 GAS M	55	2,17	38	1,5	31,5	1,24	34	1,34	
3/4"	20	F NPTF	ANSI B1.20.3	NPTF 3/4 FEMALE	HNV 34 NPT M	55	2,17	38	1,5	31,5	1,24	34	1,34	
1"	25	O/ SAE	ISO 11926-1	1-5/16"-12 UN FEMALE ORB	HNV 1- 1SAE M	66	2,6	45	1,77	37,8	1,49	41	1,61	
1"	25	F BSPP	ISO 1179-1	BSPP 1 FEMALE	HNV 1 GAS M	66	2,6	45	1,77	37,8	1,49	41	1,61	
1"	25	F NPTF	ANSI B1.20.3	NPTF 1 FEMALE	HNV 1 NPT M	66	2,6	45	1,77	37,8	1,49	41	1,61	
1-1/2"	37,5	F BSPP	ISO 1179-1	BSPP 1-1/2 FEMALE	HNV112 GAS M	126	4,96	71	2,8	44,5	1,75	65	2,56	
1-1/2"	37,5	F BSPP	ISO 1179-1	BSPP 1-1/4 FEMALE	HNV112-114GAS M	126	4,96	71	2,8	44,5	1,75	65	2,56	
2"	50	F NPTF	ANSI B1.20.3	NPTF 2 FEMALE	HNV 2 NPT M	142	5,59	97	3,82	63,25	2,49	89	3,5	

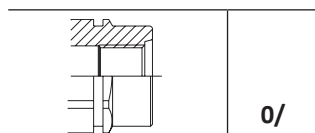
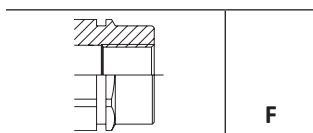

HNV Accessories

PVC dust caps



Plugs suitable for FEMALE



Caps suitable for MALE

Size			Plug Details		Size			Cap Details	
inch	mm	dash	Part number	Colour	inch	mm	dash	Part number	Colour
1/8"	3,2	02	TMH 18	red	1/8"	3,2	02	TFH 18	red
1/4"	6,3	04	TMH 14	red	1/4"	6,3	04	TFH 14	red
1/4"	6,3	04	TMH 14 N	black	1/4"	6,3	04	TFH 14 N	black
3/8"	10	06	TMH 38	red	3/8"	10	06	TFH 38	red
3/8"	10	06	TMH 38 A	orange	3/8"	10	06	TFH 38 A	orange
3/8"	10	06	TMH 38 B	blue	3/8"	10	06	TFH 38 B	blue
3/8"	10	06	TMH 38 G	yellow	3/8"	10	06	TFH 38 G	yellow
1/2"	12,5	08	TMH 12	red	3/8"	10	06	TFH 38 N	black
3/4"	20	12	TMH 34	red	1/2"	12,5	08	TFH 12	red
3/4"	20	12	TMH 34 N	black	3/4"	20	12	TFH 34	red
1"	25	16	TMH 1	red	3/4"	20	12	TFH 34 N	black
					1"	25	16	TFH 1	red

Aluminium dust caps



Plugs suitable for FEMALE



Caps suitable for MALE

Size			Plug Details		Size			Cap Details	
inch	mm	dash	Part number	Colour	inch	mm	dash	Part number	Colour
1/8"	3,2	02	TMH 18 S		1/8"	3,2	02	TFH 18 S	
1/4"	6,3	04	TMH 14 S		1/4"	6,3	04	TFH 14 S	
3/8"	10	06	TMH 38 S		1-1/2"	37,5	24	TFH112 S	
1-1/2"	37,5	24	TMH112 S		2"	50	32	TFH 2 S	
2"	50	32	TMH 2 S						

Seal Kits



For Female

Size			Seal Details	
inch	mm	dash	Material	Part Number
1/8"	3,2	02	NBR; PTFE	SK HNV 18
1/8"	3,2	02	FKM; PTFE	SK HNV 18 V
1/4"	6,3	04	NBR; PTFE	SK HNV 14
1/4"	6,3	04	FKM; PTFE	SK HNV 14 V
3/8"	10	06	NBR; PTFE	SK HNV 38
3/8"	10	06	FKM; PTFE	SK HNV 38 V
1/2"	12,5	08	NBR; PTFE	SK HNV 12
1/2"	12,5	08	NBR; PTFE	SK HNV 12 V
3/4"	20	12	NBR; PTFE	SK HNV 34
3/4"	20	12	FKM; PTFE	SK HNV 34 V
1"	25	16	NBR; PTFE	SK HNV 1
1"	25	16	FKM; PTFE	SK HNV 1 V
1-1/2"	37,5	24	NBR	SK HNV 112
1-1/2"	37,5	24	FKM	SK HNV 112 V
2"	50	32	NBR	SK HNV 2
2"	50	32	FKM	SK HNV 2 V

Every seals kit is composed of 5 or 10 pcs.