

Marine Turbine Series 900MA and 1000MA Fuel Filter/Water Separators

Installation, Operation, and Service Information



900MA



1000MA

Overview

The 900MA and 1000MA Marine Turbine Series filter assemblies protect precision engine components from dirt, rust, algae, asphaltines, varnishes, and especially water, which is prevalent in engine fuels. They remove contaminants from fuel using the following legendary three stage process:

Stage 1: Separation – As fuel enters the assembly, it moves through the centrifuge and spins off large solids and water droplets which are heavier than fuel and fall to the bottom of the collection bowl.

Stage 2: Coalescing – Small water droplets bead-up on the surface of the conical baffle and cartridge element. When heavy enough, they too fall to the bottom of the collection bowl.

Stage 3: Filtration – Proprietary Aquabloc II cartridge elements repel water and remove contaminants from fuel down to 2 micron. Aquabloc II cartridge elements are waterproof and effective longer than water absorbing elements.

Getting Started

The following customer supplied materials should be on hand before beginning installation.

- Shop Towels
- Mounting Hardware (3/8" or M10 fasteners)
- Inlet/Outlet Fittings (see Fitting chart on page 4)
- Fuel Hose (see Fuel Hose chart on page 4)
- Diesel Fuel (about 1 gallon)
- Parker Super O-lube (or equivalent)
- Thread Sealant (no thread tapes)

RACOR®

Parker Hannifin Corporation
Racor Division
PO Box 3208, 3400 Finch Rd.
Modesto, CA 95354 USA
209.521.7860 / 800.344.3286
www.parker.com/racor
e-mail: racor@parker.com



BUREAU
VERITAS



Mounting Information (no scale)

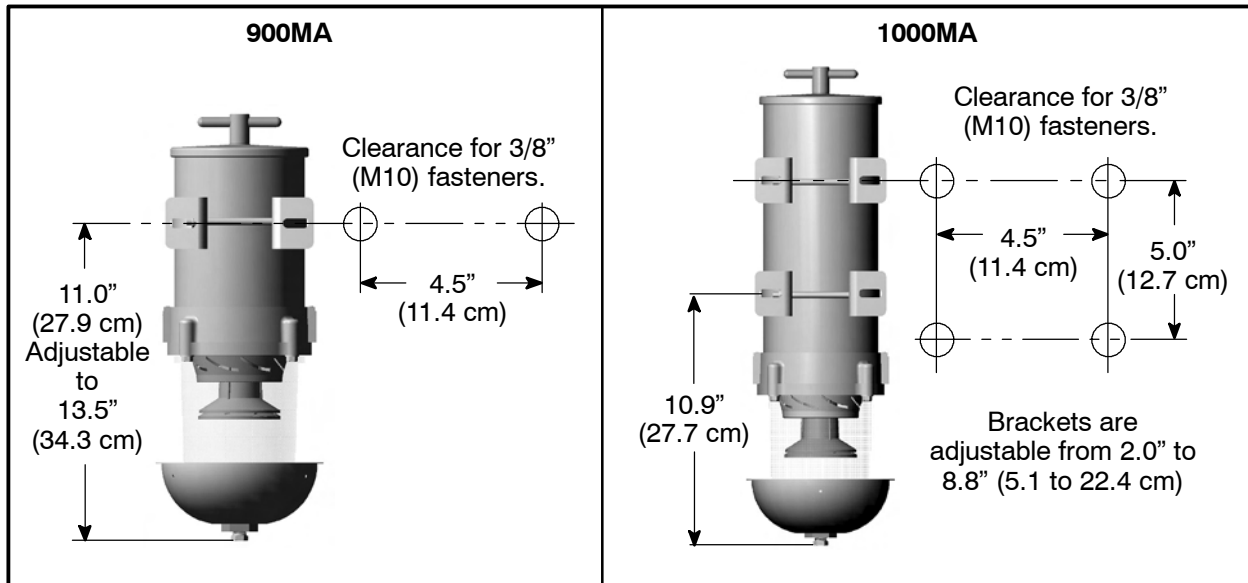

Note - mount the filter assembly as close to vertical (**V**) as possible. Do not exceed 10° from vertical or the assembly may not function properly.

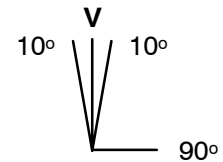

Installation Instructions

When positioning the filter assembly:

- MA filter assemblies should be installed on the vacuum side of the fuel transfer pump for optimum water separating efficiency. See 'Installation Diagram' on the next page.
- Keep fuel line restrictions to a minimum. Locate the MA filter assembly between the horizontal planes of the bottom of the fuel tank and the inlet of the fuel pump, if possible. If the MA filter assembly is installed in an application where the fuel tank is higher than the filter, a shut-off valve must be installed between the tank and the MA filter assembly INLET. This will be used when servicing the replacement element.

Before installing the filter assembly:

- Obtain good ventilation and lighting.
- Maintain a safe working environment.
- The engine must be off for installation.
- DO NOT smoke or allow open flames near the installation.

Installing the filter assembly:

- Completely remove any vacuum side filters in the fuel line between the fuel tank and the fuel pump. This is where the MA filter assembly will mount. Leaving these filters in place will add to the fuel line restriction. Filter heads cast into the engine or that are non-removable or hard piped should be serviced with a new element and left in place.
- Keep fuel flow restriction values to a minimum. Always use the maximum size fuel hose possible. Do not make sharp bends with flexible fuel hose as kinks may occur. Avoid the use of two 45° elbow fittings where one 90° elbow will work.
- When routing hose, avoid surfaces that will move, have sharp edges, or will get hot (such as exhaust piping).

900MA and 1000MA Installation Diagram

A Vacuum Side Installation is Recommended

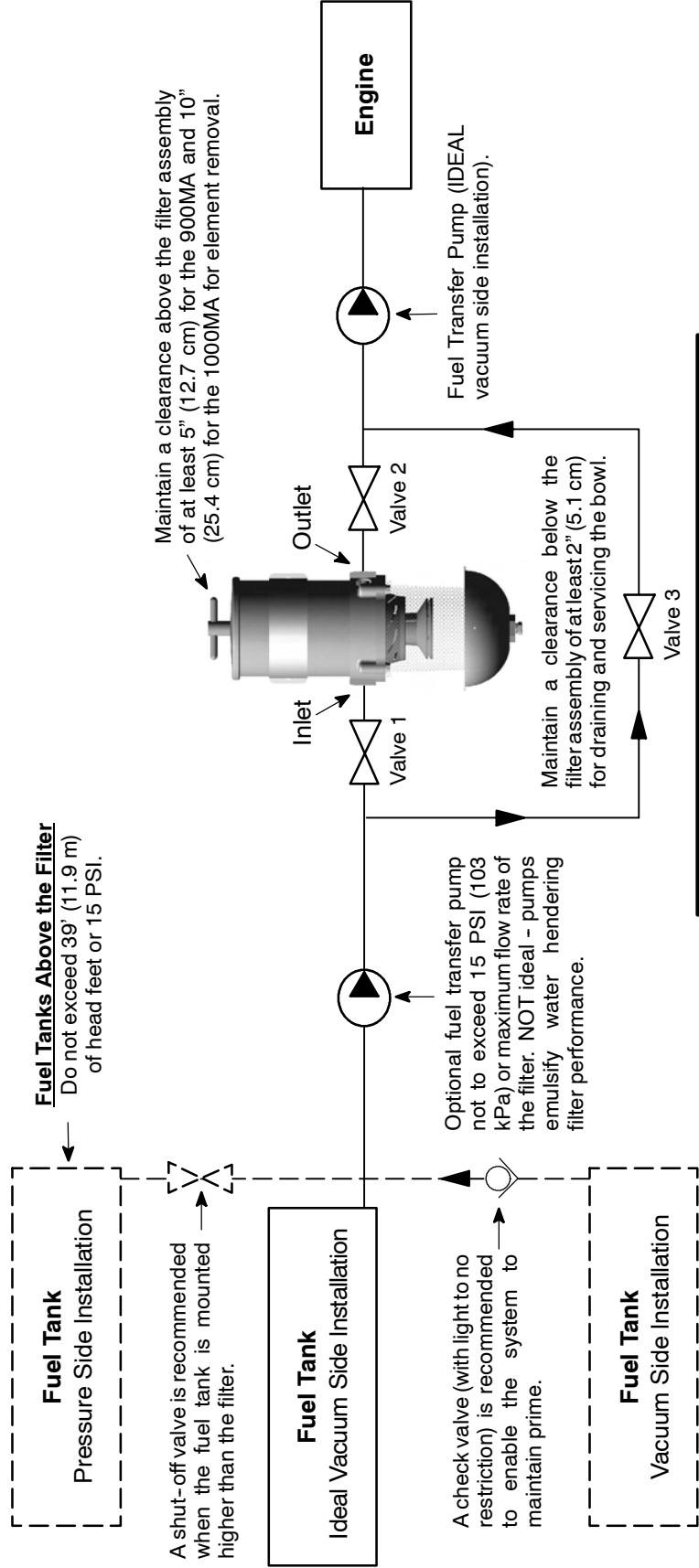





Optional Bypass Installation and Operation

The optional bypass installation allows the user to service the filter without shutting down the engine.

Valves	1	2	3
<u>Unit On-line:</u>	Open	Open	Closed
<u>Unit Off-line:</u>	Closed	Closed	Open

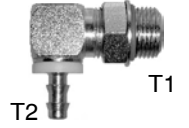
Racor Plated Steel Fittings

Part Number	Description	T1 (SAE J1926)	T2	Tube or Hose Size	Picture (No Scale)
9010-10-8 9010-10-10	SAE O-ring (T1) to JIC 37° Male Flare (T2) Elbow	7/8"-14 UNF 7/8"-14 UNF	3/4"-16 UNF 7/8"-14 UNF	8 10	
9020-10-8 9020-10-10	SAE O-ring (T1) to JIC 37° Male Flare (T2) Straight	7/8"-14 UNF 7/8"-14 UNF	3/4"-16 UNF 7/8"-14 UNF	8 10	
911-O10-F8 911-O10-F12	SAE O-ring (T1) to Female NPT (T2) Straight	7/8"-14 UNF 7/8"-14 UNF	1/2"-14 NPT 3/4"-14 NPT	8 12	
913-O10-H8 913-O10-H10 913-O10-H12	SAE O-ring (T1) to Hose Barb (T2) Elbow	7/8"-14 UNF 7/8"-14 UNF 7/8"-14 UNF	1/2" Hose Barb 5/8" Hose Barb 3/4" Hose Barb	8 10 12	
911-O10-H8 911-O10-H10 911-O10-H12	SAE O-ring (T1) to Hose Barb (T2) Straight	7/8"-14 UNF 7/8"-14 UNF 7/8"-14 UNF	1/2" Hose Barb 5/8" Hose Barb 3/4" Hose Barb	8 10 12	

Note: T1 is the side of the fitting that will attach to the MA filter housing. Additional fitting options may be available from a Parker dealer. Call 1-800-C-PARKER (1-800-272-7537) for the dealer nearest you.

Racor Fuel Hose

Racor fuel hose is fire resistant and meets SAE J1527 Type A class and SAE J1942 standards. This hose delivers test proven performance in a wide operating temperature range, constant working pressure in popular sizes, long-lasting reinforced construction, kink and cut resistance, and compatibility with a variety of standard fittings.



Part Number	Hose ID	Working Pressure	Burst Pressure	Min. Bend Radius
CGH-10	1/2" (12.5 mm)	500 PSI (3.5 MPa)	2000 PSI (14 MPa)	2 1/4" (55 mm)
CGH-12	5/8" (16 mm)	500 PSI (3.5 MPa)	2000 PSI (14 MPa)	2 3/4" (70 mm)
CGH-16	7/8" (22 mm)	500 PSI (3.5 MPa)	2000 PSI (14 MPa)	3 1/2" (90 mm)

Note - additional sizes are available - call Racor at 1-800-344-3286.

Additional Features

- High-tensile steel wire braid.
- No-Skive - does not require the removal of outer cover to install.
- USCG-rated for gasoline, diesel, lube oil and hydraulic systems.
- Working temperature of -4°F to +212°F (-20°C to +100°C).

Priming Instructions

1. Remove the T-handle and lid from the top of the filter assembly.
2. Fill the filter assembly with clean fuel.
3. Lubricate lid gasket and T-handle O-ring with clean fuel or motor oil.
4. Replace the lid and T-handle and tighten snugly by hand only – **do not use tools**.
5. If applicable, refer to the equipment Operator's Service Manual to complete the fuel priming procedure.
6. Start engine and check for fuel system leaks.
7. Correct as necessary with engine off and pressure relieved from filter assembly.

Service Instructions

Draining Water:

Frequency of water draining is determined by the contamination level of the fuel. Inspect or drain the collection bowl of water daily or as necessary. The collection bowl must be drained before contaminants reach the top of the turbine or when the Water Detection Module (optional) indicates it's time to 'drain water'.

Vacuum Applications / Installations:

1. Close the inlet valve (or valve #1) and open the drain on the bottom of the bowl with a suitable container in place.
2. Close the drain after all the water and contaminants have been evacuated – DO NOT leave the drain open too long as it will eventually completely drain the entire filter assembly of water AND fuel.
3. Follow 'Priming Instructions'.

Pressure Applications / Installations:

1. Open the drain on the bottom of the bowl to evacuate water and contaminants with a suitable collection container in place. Head pressure will push any water and contaminants out of the drain while keeping the filter primed.
2. Close the drain after all the water and contaminants have been evacuated – DO NOT leave the drain open too long as it will eventually completely drain the entire filter assembly of water AND fuel, and possibly drain the entire tank.

Element Replacement:

Frequency of element replacement is determined by the contamination level of the fuel. Replace the elements every 10,000 miles, every 500 hours, every other oil change, when the vacuum gauge (optional) reads between 6 to 10 inches of mercury (inHg), if power loss is noticed, or annually, whichever ever comes first. *Note - always carry extra replacement elements as one tankful of excessively dirty fuel can plug a filter.*

Use only genuine Racor Aquabloc II replacement elements - see Replacement Part List.

All Applications:

1. Bypass filter assembly with bypass valves, if applicable.
2. Remove the T-handle and lid.
3. Remove the element by holding the bail handles and slowly pulling upward with a twisting motion. Dispose of properly.
4. Replace old lid gasket and T-handle O-ring with new seals (supplied with new element). Lubricate both seals with motor oil or diesel fuel before installation.
5. Refer to 'Priming Instructions', otherwise, fill the unit with clean fuel, then replace the lid and T-handle and tighten snugly by hand only – do not use tools.

Note - above ground tanks or transfer pump applications may use head pressure to prime the filter assembly.

Installing Optional Water Detection Components

Note – Racor electrical options are for use with diesel applications only.

Water Sensor



MA filter assemblies can be ordered with a water sensor installed at the factory. The following instructions are for MA filter assemblies that do NOT have a water sensor already installed. All water sensors must be used with a special Racor electronic detection module to function properly. Due to the variety of detection modules available, they are sold separately and installation instructions are supplied with each kit.

1. Drain the MA filter assembly completely.
2. Remove the drain assembly and deflector shield from the bottom of the filter.
3. Take out the water sensor plug on the side of the bowl and discard properly.
4. Lubricate the water sensor O-ring with Parker Super O-lube or equivalent.
5. Thread the water sensor into the probe port on the side of the bowl. Tighten snugly.
6. Attach the Racor detection module to the wire leads of the water sensor. Specific instructions for this step are included with each detection module.
7. Reassemble the deflector shield and drain assembly to the filter.
8. Prime the MA filter assembly by filling with fuel.
9. Start engine and check for leaks. Correct as necessary.

Water Detection Modules

Racor water detection modules are available in a wide selection for various installation requirements. Under dash, in-dash and remote mount, these solid-state units may be used with any Racor water sensor. They are manufactured using the highest quality materials and are all 100% electronically tested.

An electronic detection module analyzes electrical resistance at the water sensor and determines if water is present. If so, the detection module operates to indicate water, based on its features listed below. All units reset automatically after water is removed (unless specified). Below are some of our more popular modules, others are available.

Part Number	Description	Voltage	Picture
RK 12870	Under-dash mount. Light and audio. Illuminates and sounds when water is detected. Plastic enclosure measures 1.4" square by 1.25" deep. Power draw is 1 milliamp.	12 vdc	
RK 12871	Same as above.	24 vdc	
RK 20726	In-dash mount. Light and audio. Red 'DRAIN' lamp illuminates continuously and horn sounds momentarily when water is detected. Initial power-up self diagnosis feature and circuit protection included. Plastic 2" gauge. Power draw is 3 milliamps for 12 vdc and 13 milliamps for 24 vdc.	12 or 24 vdc	
RK 20725	Under-dash mount. Light only. Green 'ON' lamp illuminates with power and red 'DRAIN' lamp illuminates when water is detected. Initial power-up self diagnosis feature and circuit protection included. Plastic enclosure measures 2.75" by 1.0" by 1.5". Power draw is 10 milliamps.	12 vdc	
RK 20725-24	Same as above.	24 vdc	

Replacement Part List

	<u>Part Number</u>	<u>Description</u>
1	RK 11-1945 11350	T-handle and O-ring Kit T-handle O-ring
2	RK 11-1933-04 11007	Lid and Lid Gasket Kit Square Cut Gasket (Lid and Bowl)
3	RK 19002-02 RK 11021-02	900MA - Outer Cylinder Kit 1000MA - Outer Cylinder Kit
4	RK 11-1931 RK 11-1930	900MA - Return Tube Kit 1000MA - Return Tube Kit
5	RK 11815-102	Body Clamp Bracket Kit (1)
6	2040SM-OR 2040TM-OR 2040PM-OR 2020SM-OR 2020TM-OR 2020PM-OR	900MA - 2 Micron Element w/ Seals 900MA - 10 Micron Element w/ Seals 900MA - 30 Micron Element w/ Seals 1000MA - 2 Micron Element w/ Seals 1000MA - 10 Micron Element w/ Seals 1000MA - 30 Micron Element w/ Seals
7	RK 11-1953	Valve, Spring & O-ring Kit
8	11007	Square Cut Gasket (Lid and Bowl)
9	RK 11-1679	Body Plug Kit
10	RK 11028B	Checkball and Seal Kit
11	RK 11-1939	Turbine Centrifuge / Conical Baffle Kit
12	RK 11-1938	See-thru Bowl w/ Drain & Plug Kit
13	RK 21069 RK 22838	Water Sensor Kit Water Sensor Plug Kit
14	RK 11-1776-03	7/8" - 14 Body Kit
15	RK 11037A-01	5" Diameter Bowl Ring Kit
16	RK 11542	Capscrew Kit (4)
17	RK 11868	Deflector Shield Kit
18	RK 11-1910	Complete Bowl Drain Fitting Kit

Additional Parts

RK 11-1952	Complete Seal Service Kit
RK 31605	Parker Super O-lube
RK 19492	UL Approved Petcock Valve

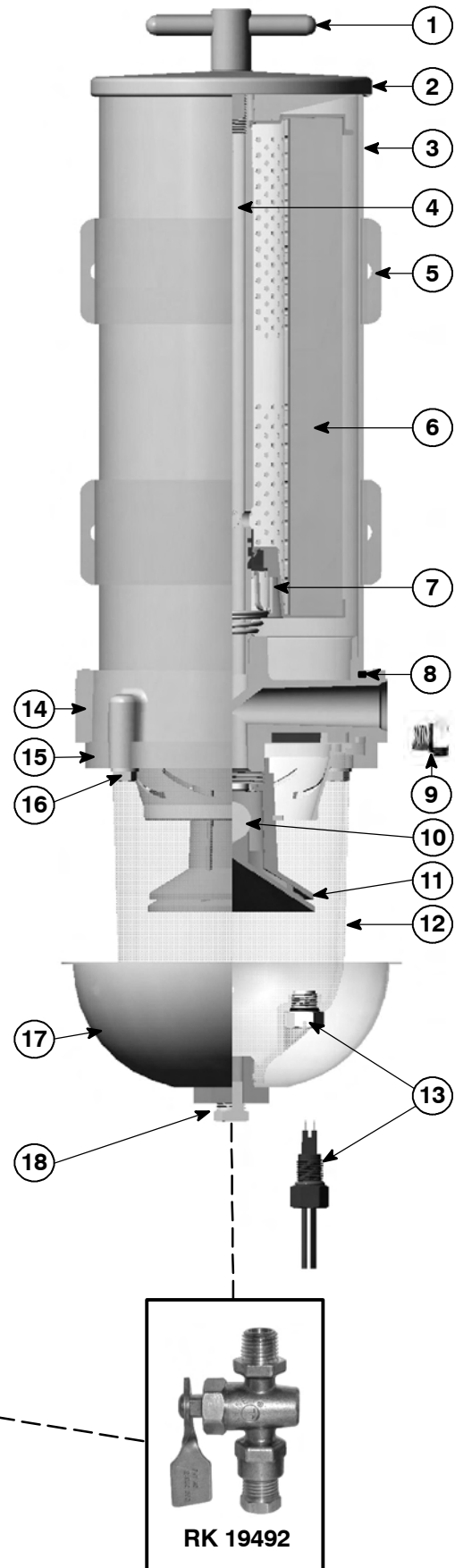

Certifications and Standards for Marine Fuel Systems

- Underwriters Laboratories (UL), Inc. Marine Listed (MQ397) (168Y).
- UL classified in accordance with ISO 11088 for CE systems.
- American Boat & Yacht Council (ABYC), Inc., Individual Standard, H-33 (diesel fuel systems), and H-24 (gasoline fuel systems).
- American Society for Testing and Materials (ASTM), ASTM F-1201.
- Bureau Veritas Marine, Type Approval (05634/BXBV).
- United States Coast Guard (USCG) accepted for use aboard inspected vessels per 33 CFR (Code of Federal Regulations).
- National Marine Manufacturing Association (NMMA), member.
- American Bureau of Shipping (ABS), Product Type Approval (certification #00-SF37508-X). This filter complies with the regulations of ABS **when plumbed in parallel with another like filter**. This ensures that one filter can be isolated and safely serviced even while the engine is running. See diagram below.

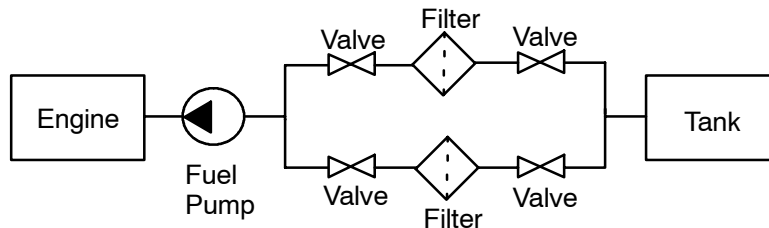

Also Available From Racor...

Marine Air Replacement Filters - Brochure 7501

Racor now offers replacement filters for marine applications. These filters are direct replacements for the intake air filter portion of various brands of air filters/silencers.



Crankcase Ventilation Filtration Systems - Brochures 7496, 7501 and 7567

By trapping crankcase blow-by and recycling engine emissions through high performance filters, Racor CCV systems offer an effective solution to reduce contaminated crankcase emissions. Racor CCV systems provide protection for engines and the environment - eliminating the hazardous oily film that used to coat engine compartments and equipment. Features include:

- Keeps engine compartments and components clean.
- Prevents clogging of engine intakes, turbochargers and intercoolers.
- Improves reliability and maintainability of diesel engines.
- Reduces environmental pollution from crankcase emissions.



Specifications

Basic Models	900MA	1000MA
Maximum Flow Rate	90 GPH (341 LPH)	180 GPH (681 LPH)
Port Size (SAE J1926)	7/8"-14 UNF	7/8"-14 UNF
Replacement Elements: 2 micron 10 micron 30 micron	2040SM-OR 2040TM-OR 2040PM-OR	2020SM-OR 2020TM-OR 2020PM-OR
Minimum Service Clearance Above assembly Below assembly	5 in. (12.7 cm) 2 in. (5.1 cm)	10 in. (25.4 cm) 2 in. (5.1 cm)
Height	16.2 in. (41.1 cm)	22.0 in. (55.9 cm)
Depth	6.0 in. (15.2 cm)	6.0 in. (15.2 cm)
Width	7.0 in. (17.8 cm)	7.0 in. (17.8 cm)
Weight (dry)	6.0 lb (2.7 kg)	10.0 lb (4.5 kg)
Clean Element Pressure Drop	0.30 PSI (2.07 kPa)	0.43 PSI (2.97 kPa)
Maximum Allowable Pressure ¹	25 PSI (172 kPa)	25 PSI (172 kPa)
Water In Bowl Capacity	10.3 oz. (305 ml)	10.3 oz. (305 ml)
Available Options: ² Water Sensor Heater	Yes No	Yes No
Operating Temperature	-40° to +255°F / -40° to +121°C	

Special Notes

¹ Pressure installations are applicable up to the maximum PSI shown. Vacuum installations are recommended.

² Not for use on gasoline applications.

Also Available From Racor...

Additive	Part Number	Size	Treatment	Benefits
Diesel Biocide	ADT 2116	16 oz. Bottle	1,280 Gallons	<ul style="list-style-type: none"> • Concentrated formula • Kills bacteria and fungi • Prevents corrosion
	ADT 2201	1 Gallon Bottle	10,240 Gallons	
Diesel Performance Plus+	ADT 3116	16 oz. Bottle	80 Gallons	<ul style="list-style-type: none"> • Highly concentrated formula • Provides superior lubrication • Increases power

Note - treatment ratios are per container. All additives are alcohol free. Additional additives are available - Log-on to www.parker.com/racor or see brochure 7518 for more information.

Troubleshooting

Note – Correct external fuel leaks immediately! These conditions will result in reduced engine performance such as: hard starting, stalling, reduced power and other associated problems.

New filter installations must be filled with fuel and the fuel system must be adequately primed following the **engine manufacturer's recommendations**, if applicable. Existing installation difficulties are usually associated with improper priming procedures or damage to the unit or fuel system. The result is either internal air suction or external fuel leakage. Diagnosis should be in the following steps:

1. Check the fuel tank level and make sure any fuel delivery valves are in the open position, as applicable.
2. Ensure the T-handle, bowl fasteners and fuel fittings are tight. Also verify that the bowl drain is closed.
3. If the Racor element is new, check potential restriction at the fuel tank draw tube. An in-tank strainer may be plugged.
4. Review some of the workings of the units below to possibly uncover other solutions.

Correct Application – It is very important that the MA filter assembly is not 'under specified' for the application. The maximum fuel flow rating of the MA filter assembly must not be exceeded. Doing so will reduce efficiency and de-gas (pull air from) the fuel. Use the formula **Horsepower (HP) X 0.18 = Gallons Per Hour (GPH)** of fuel flow rate for your engine. Example – If your engine is 400 HP, then your GPH is 72. The maximum flow rate of your Racor filter should be higher than your engine's GPH. In this case we would recommend a 900MA filter assembly (90 GPH max flow rate). You can always put a larger filter on your engine than necessary, but you never want to install a filter that is too small.

Filter Elements – Replacement elements are available in 2, 10 and 30 micron ratings. Filtration needs are based on application, fuel quality, maintenance schedules and operating climates. A simple rule to remember is – the finer the filtration, the more frequent the filter change. *Always carry extra replacement elements with your equipment as one tankful of excessively contaminated fuel can plug an element.* When clogged to the maximum capacity, elements will have a brown to black color or tar like contaminants may be present – this is normal. An appearance of a multi-colored slime (which may have a foul odor) is an indication of microbiological contamination. This condition must be treated immediately. Severe conditions must be corrected by a repair facility.

Note – Never operate the filter assembly without the element in place – the element safety valve will not expose the outlet hole on the fuel return tube if the element is removed. Instead, punch the emergency tab on the top of the element and leave in place. Puncturing the emergency tab will bypass all filtration and send unfiltered fuel to your engine. Service the element as soon as possible to avoid harmful contaminants flowing downstream to the engine.

Water Sensors – This feature alerts the operator of a high-water condition. The bowl is then drained of water at the earliest convenience. Note – a Racor water detection module is needed to work with the in-bowl sensor. The unit should activate when the water reaches the sensor tips (and when they measure between 47,000 and 100,000 ohms of resistance, depending on the detection module used). If not, the tips may be fouled with a coating. Remove the sensor and clean the tips with a cloth. Run a jumper wire between the tips with the ignition ON to test the system. Difficulties usually lie in the wire connections, power source, or an independent ground.

Troubleshooting

All Racor MA filter assemblies are 100% tested to ensure a leak-proof, quality product. **Note** - Correct external fuel leaks immediately! In the event difficulties are experienced with your filter assembly or a problem appears to prevent the engine from running smoothly, follow the quick-help illustration below or refer to the procedures on the previous page. **Note** - Apply Parker Super O-lube (part number RK 31605) or equivalent to all seals at major attachment points to maintain integrity, seal elasticity, to fill small voids and provide protection from degradation.

Perform the following checks with the engine OFF (and applicable valves closed). For replacement parts, refer to the Replacement Part section of this manual.

Damaged, worn, or dirty seals will allow air ingestion. Inspect and replace all seals as needed. Clean the sealing surfaces of dirt or debris every time the element is replaced.

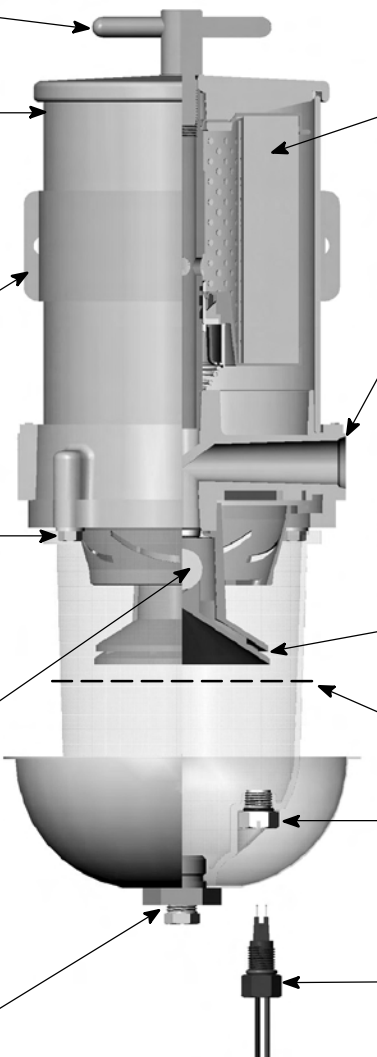

Hand tighten the T-handle only!
Do not use tools.

If the element is changed or the assembly drained for any reason, repriming the assembly (filling with fuel) may be necessary. Fill to just above the top of the element before replacing the lid.

If the carriage bolt has been loosened, do not overtighten it as this may distort the cylinder roundness.

The four self-tapping capscrews must not be overtightened to avoid stripping out the body threads. After disassembly, start threads by hand prior to using tools. Specification: 55-65 in.lbs.

The hollow aluminum check ball floats up against the seal when the fuel is stopped thus preventing fuel bleed-back. If your unit loses prime, inspect upstream hose connections first otherwise, disassemble the unit and inspect the seal and ball.

Air bubbles or fuel leakage appearing from the drain may indicate that the drain is not closed completely. Specification: 30-35 in.lbs.

The element should be replaced every 10,000 miles, every 500 hours, every other oil change, annually, or at the first indication of power loss, whichever occurs first. For Construction and Agricultural use, change the filter every 300 hours.

SAE O-ring ports should have a smooth angled seat for sealing. Do not scratch this surface. Check O-ring for damage.

The housing plug O-ring must not be damaged or swollen. Tighten snugly. Specification: 15-20 in.lbs.

Air bubbles appearing from the turbine are an indication of an upstream leak between the Racor inlet and the fuel tank pick-up tube.

Drain water (if present) before it gets to this level.

A water sensor plug is installed if the water sensor option is not selected. Tighten snugly. Specification: 15-20 in.lbs.

The water sensor (if equipped) should activate when water contacts the tips. Air bubbles or fuel leakage appearing from the sensor may indicate that it is loose or that the O-ring is damaged. Tighten or disassemble and inspect. Specification: 15-20 in.lbs.

RACOR LIMITED WARRANTIES STATEMENT

All products manufactured or distributed by Racor are subject to the following, and only the following, LIMITED EXPRESS WARRANTIES, and no others: For a period of one (1) year from and after the date of purchase of a new Racor product, Racor warrants and guarantees only to the original purchaser-user that such a product shall be free from defects of materials and workmanship in the manufacturing process. The warranty period for pumps and motors is specifically limited to ninety (90) days from date of purchase. A product claimed to be defective must be returned to the place of purchase. Racor, at its sole option, shall replace the defective product with a comparable new product or repair the defective product. This express warranty shall be inapplicable to any product not properly installed and properly used by the purchaser-user or to any product damaged or impaired by external forces. THIS IS THE EXTENT OF WARRANTIES AVAILABLE ON THIS PRODUCT. RACOR SHALL HAVE NO LIABILITY WHATSOEVER FOR CONSEQUENTIAL DAMAGES FLOWING FROM THE USE OF ANY DEFECTIVE PRODUCT OR BY REASON OF THE FAILURE OF ANY PRODUCT. RACOR SPECIFICALLY DISAVOWS ALL OTHER WARRANTIES, EXPRESS OR IMPLIED INCLUDING, WITHOUT LIMITATION, ALL WARRANTIES OF FITNESS FOR A PARTICULAR PURPOSE (EXCEPT FOR THOSE WHICH APPLY TO PRODUCT OR PART THEREOF THAT IS USED OR BOUGHT FOR USE PRIMARILY FOR PERSONAL, FAMILY, OR HOUSEHOLD PURPOSES), WARRANTIES OF DESCRIPTION, WARRANTIES OF MERCHANTABILITY, TRADE USAGE OR WARRANTIES OR TRADE USAGE.

WARNING

Failure or improper selection or improper use of the products and/or systems described herein or related items can cause death, personal injury and property damage. This document and other information from Parker Hannifin Corporation, its subsidiaries and authorized distributors provide product and/or system options for further investigation by users having technical expertise. It is important that you analyze all aspects of your application and review the information concerning the product or system in the current product catalog. Due to the variety of operating conditions and applications for these products or systems, the user, through its own analysis and testing, is solely responsible for making the final selection of the products and systems and assuring that all performance, safety and warning requirements of the applications are met. The products described herein, including with limitation, product features, specifications, designs, availability and pricing, are subject to change by Parker Hannifin Corporation and its subsidiaries at any time without notice.

The following statement is required pursuant to proposition 65, applicable in the State of California: 'This product may contain a chemical known to the State of California to cause cancer and reproductive toxicity'.