

MC 5M - MC 6P - MC 7P

Instructions for use

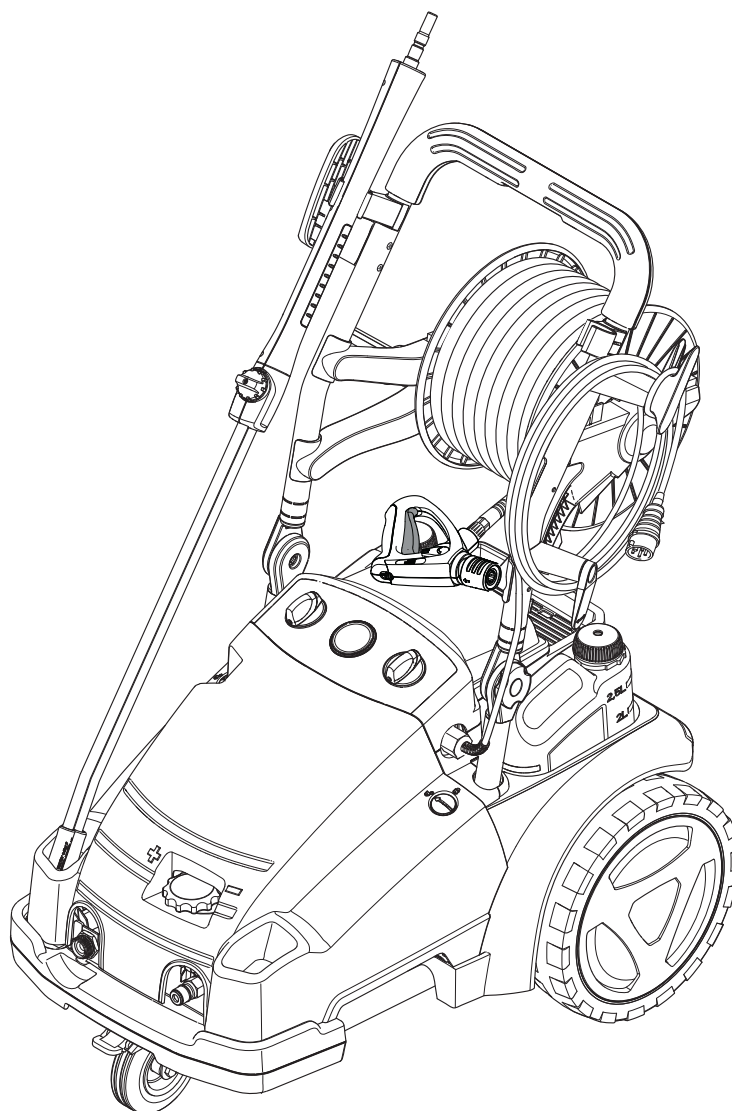

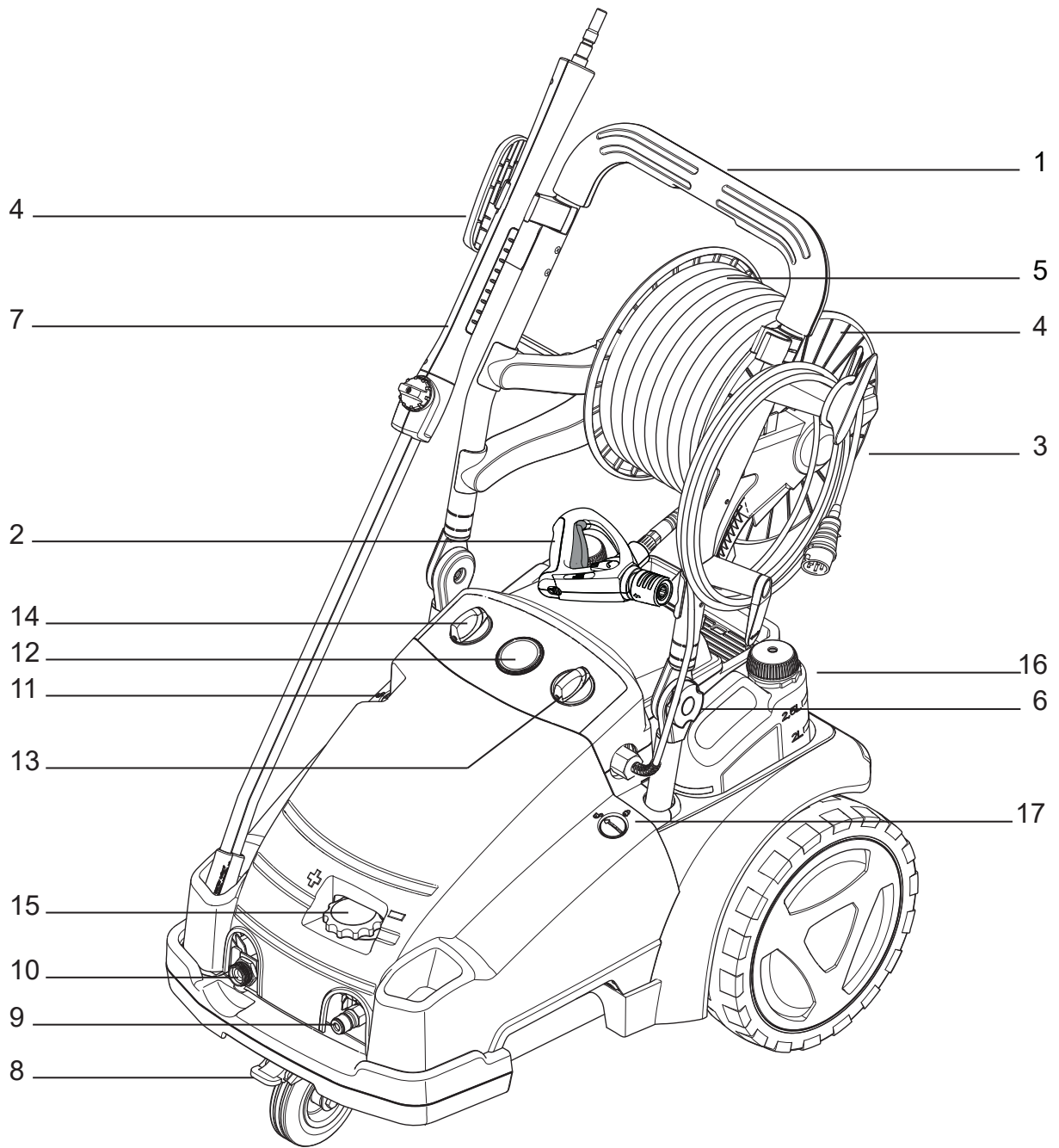

B1

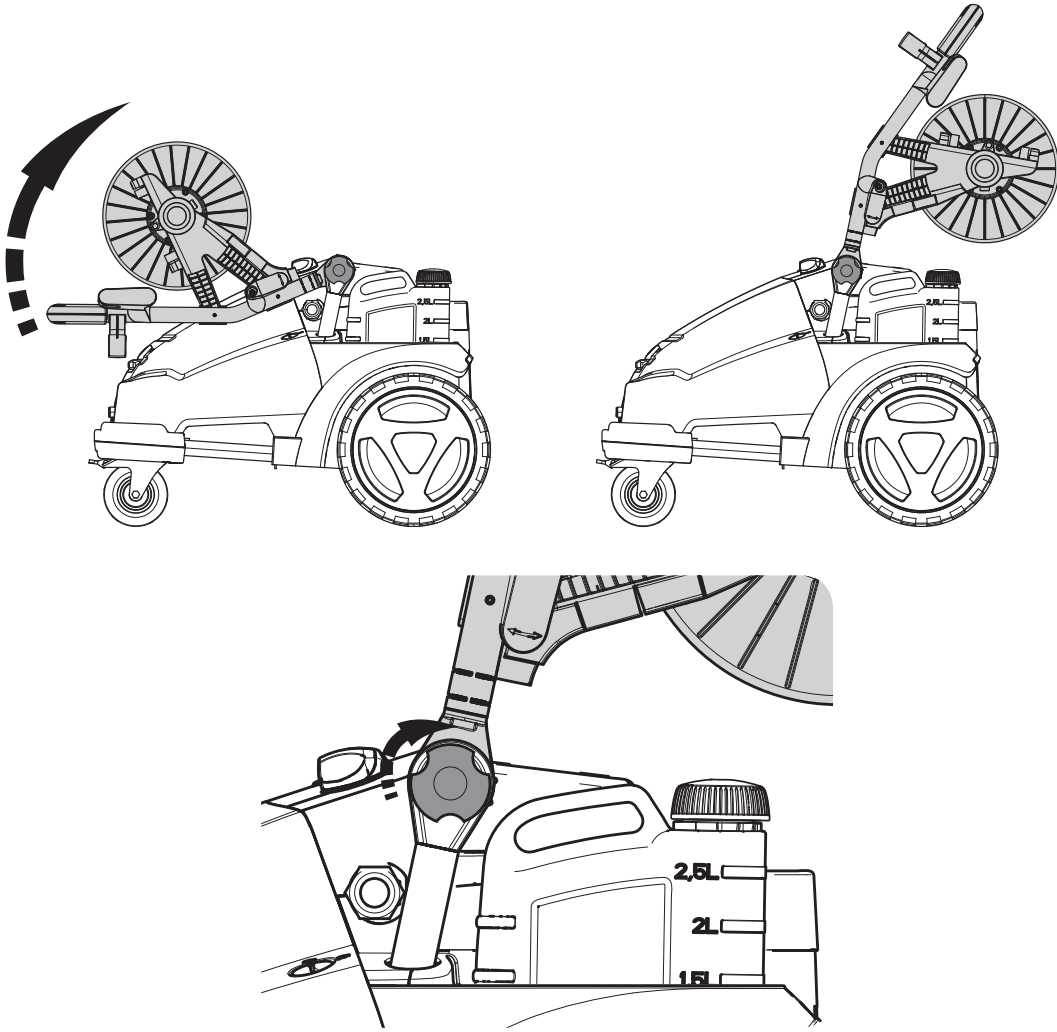

C

C1

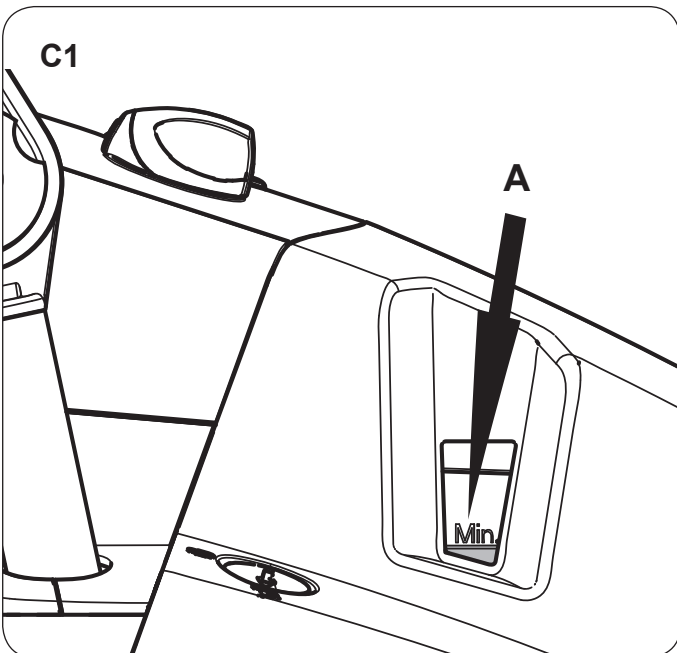

C2

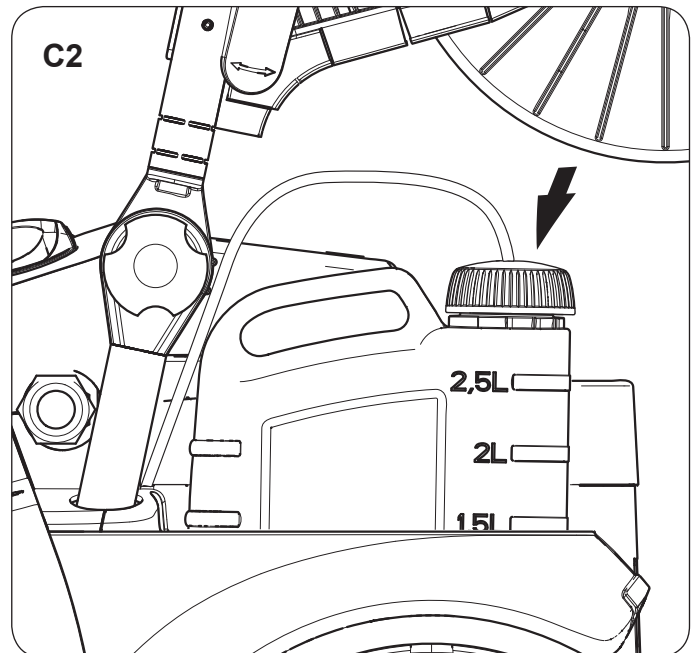

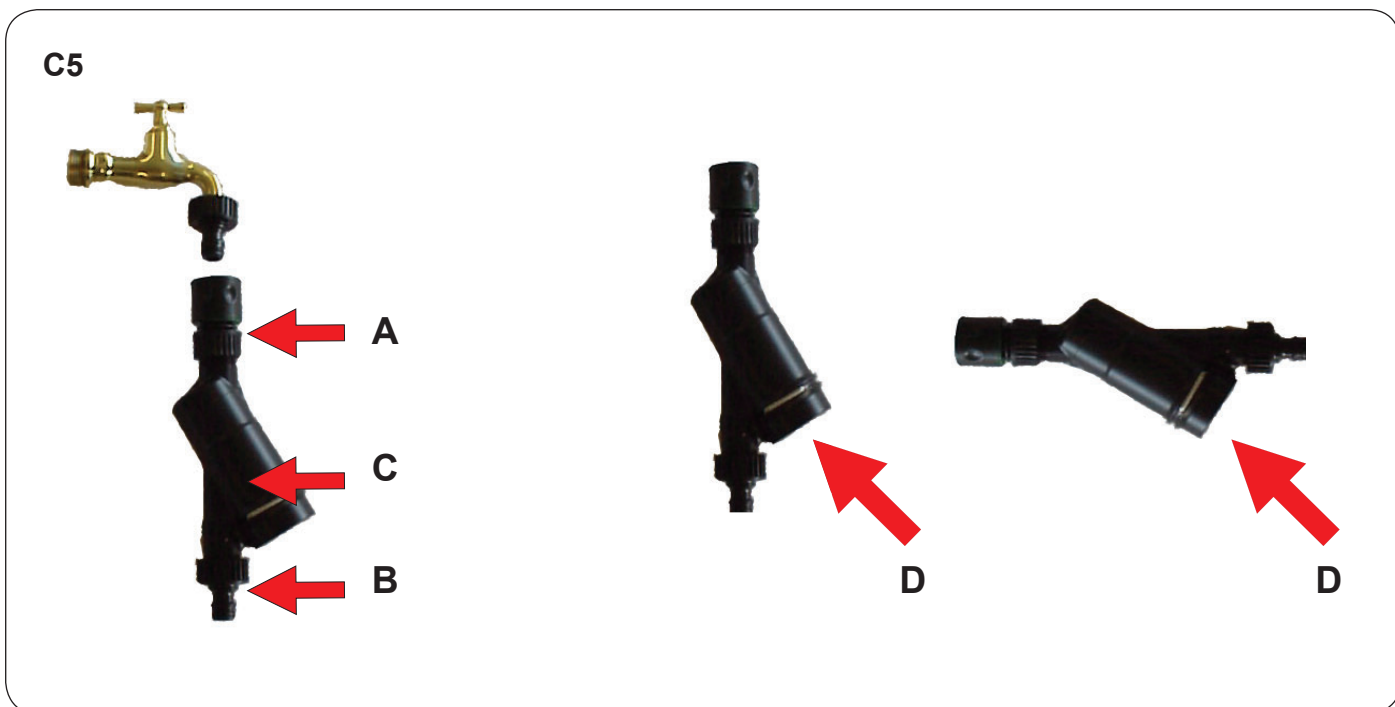
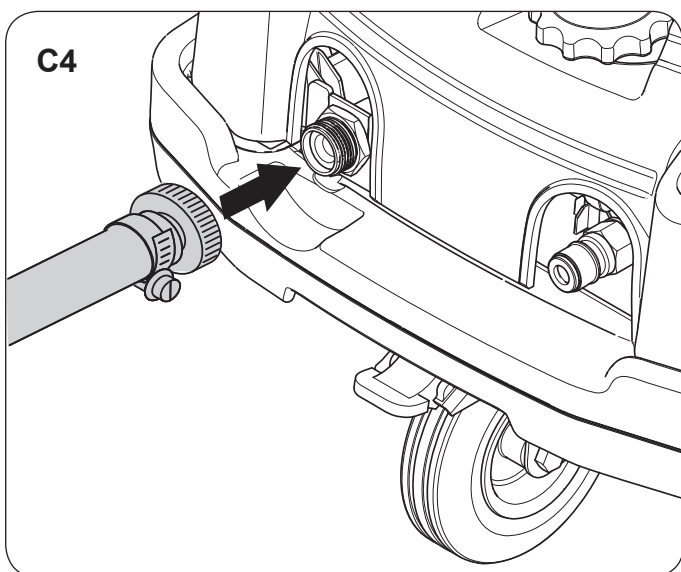
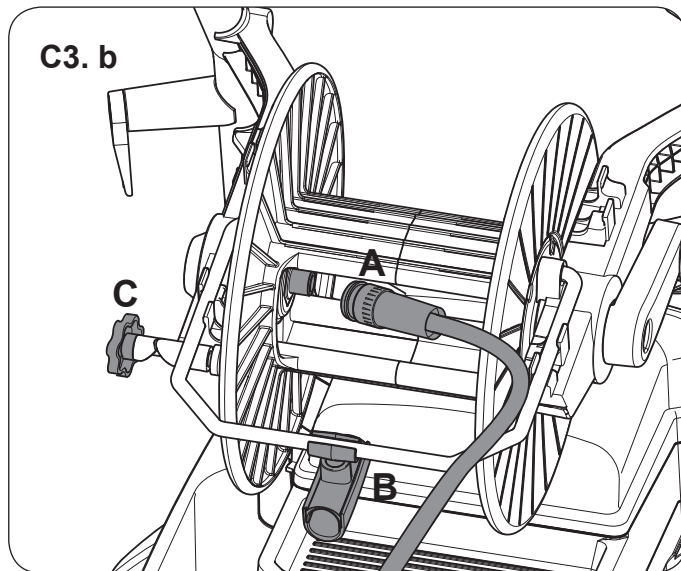
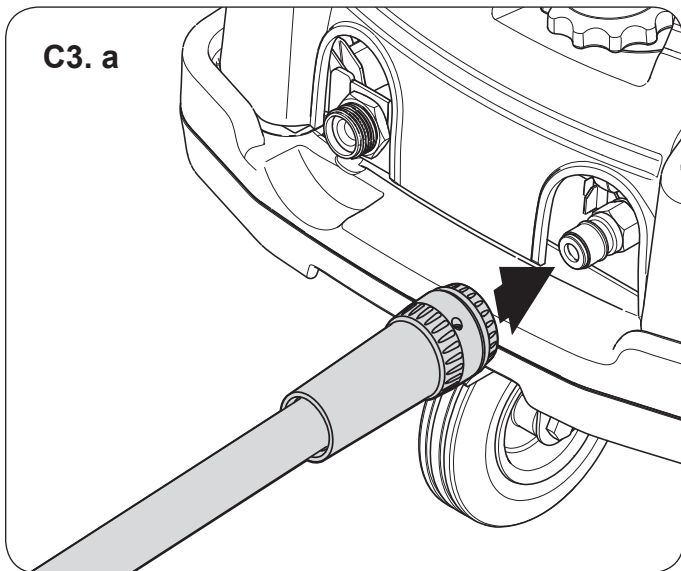

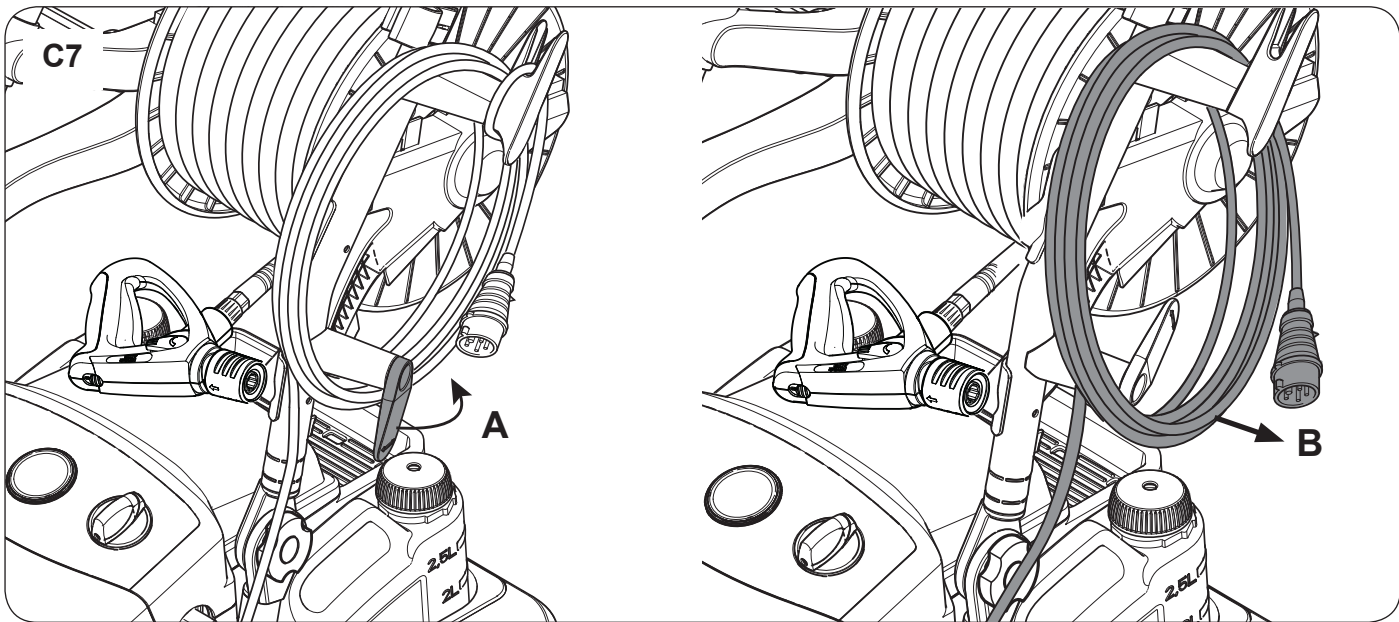
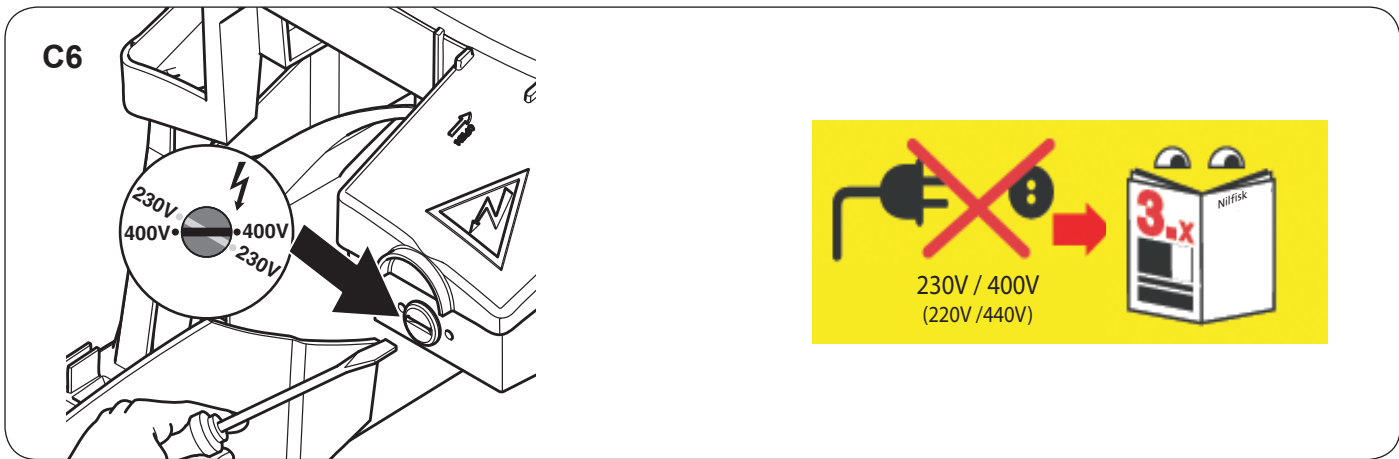

D

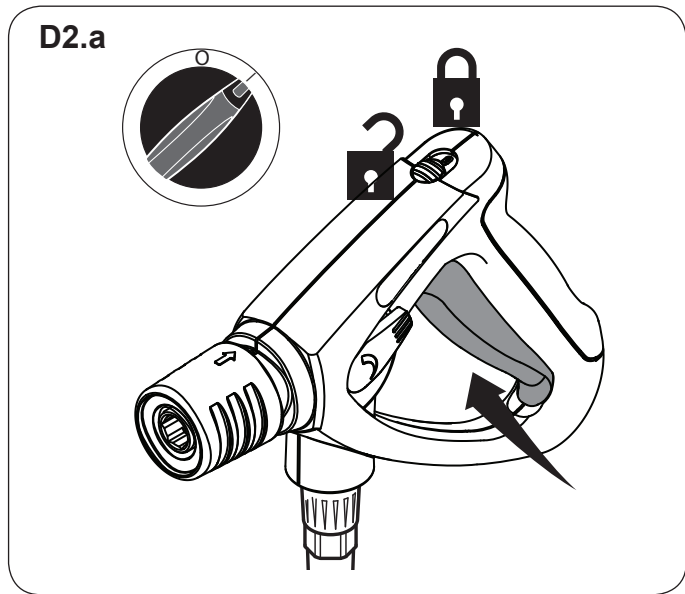
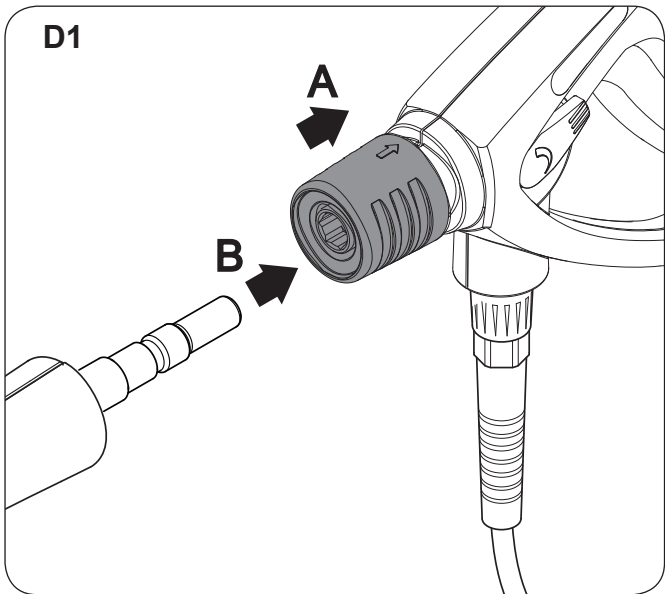

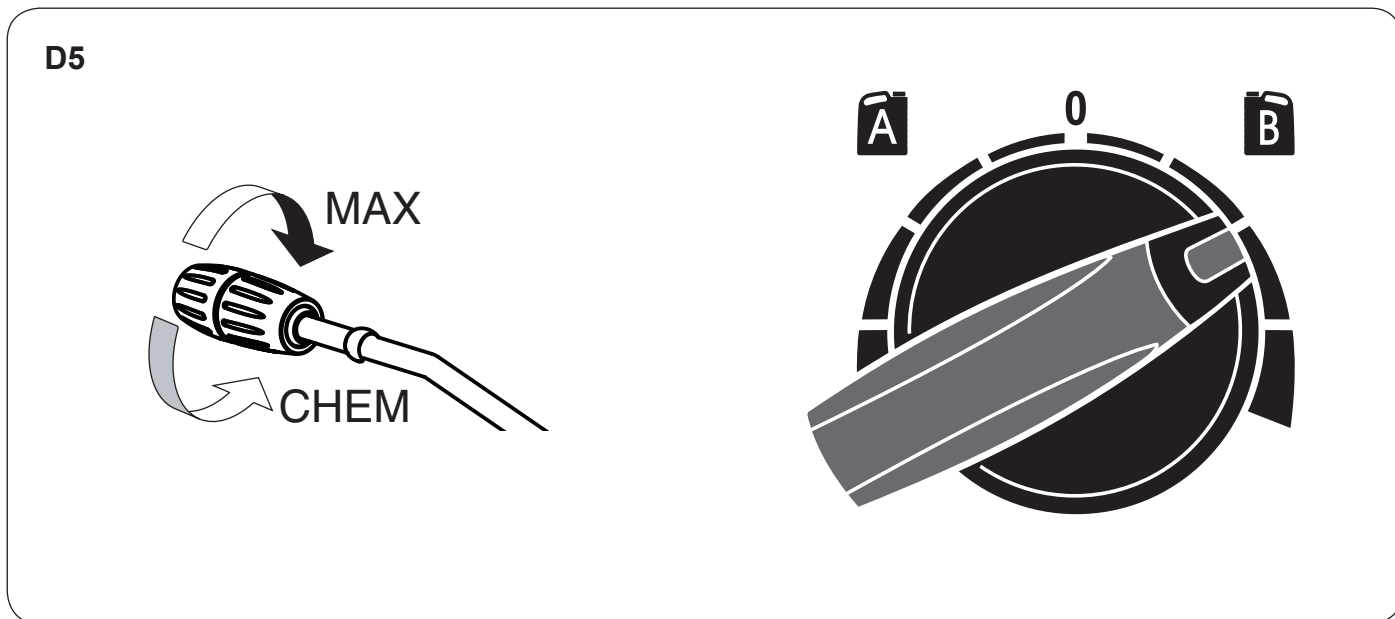
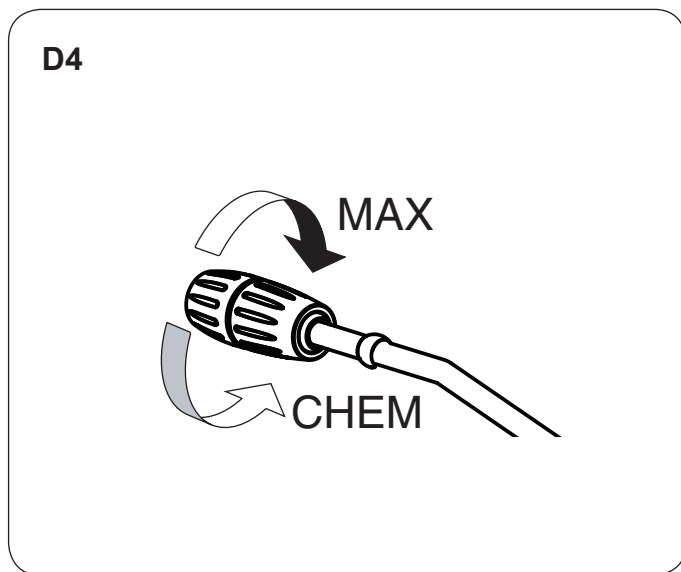
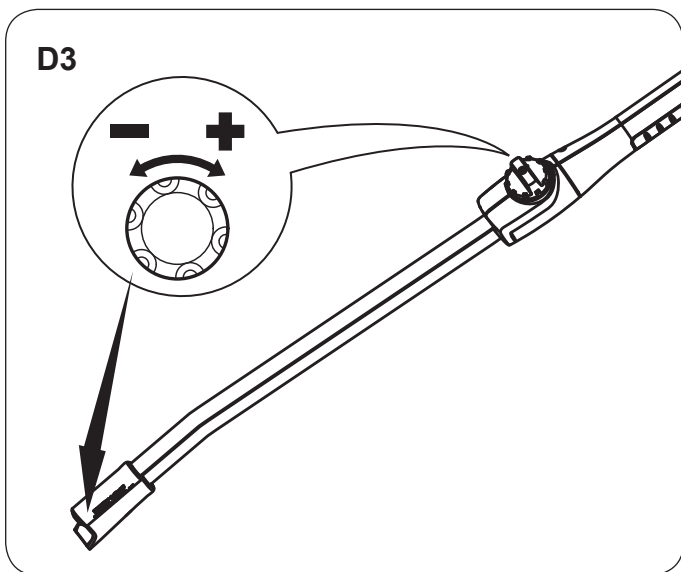
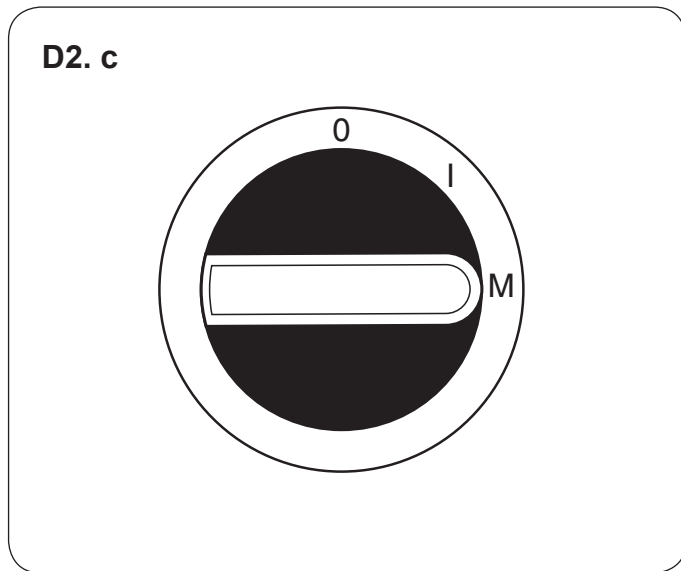
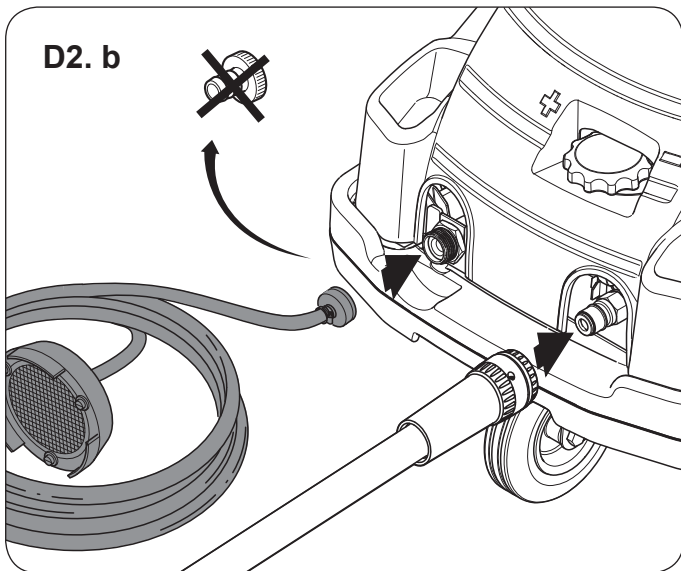

E1

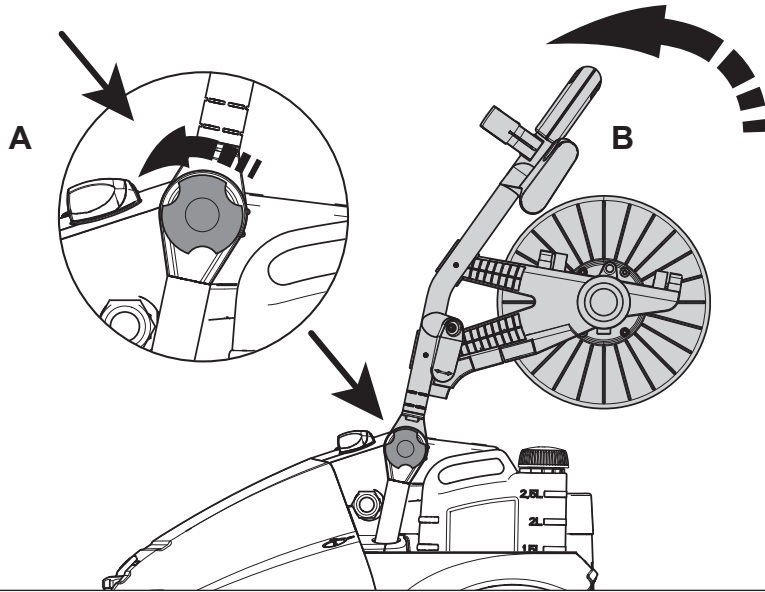

E2

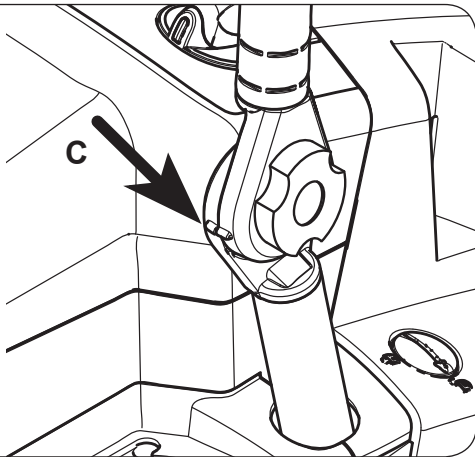

E3

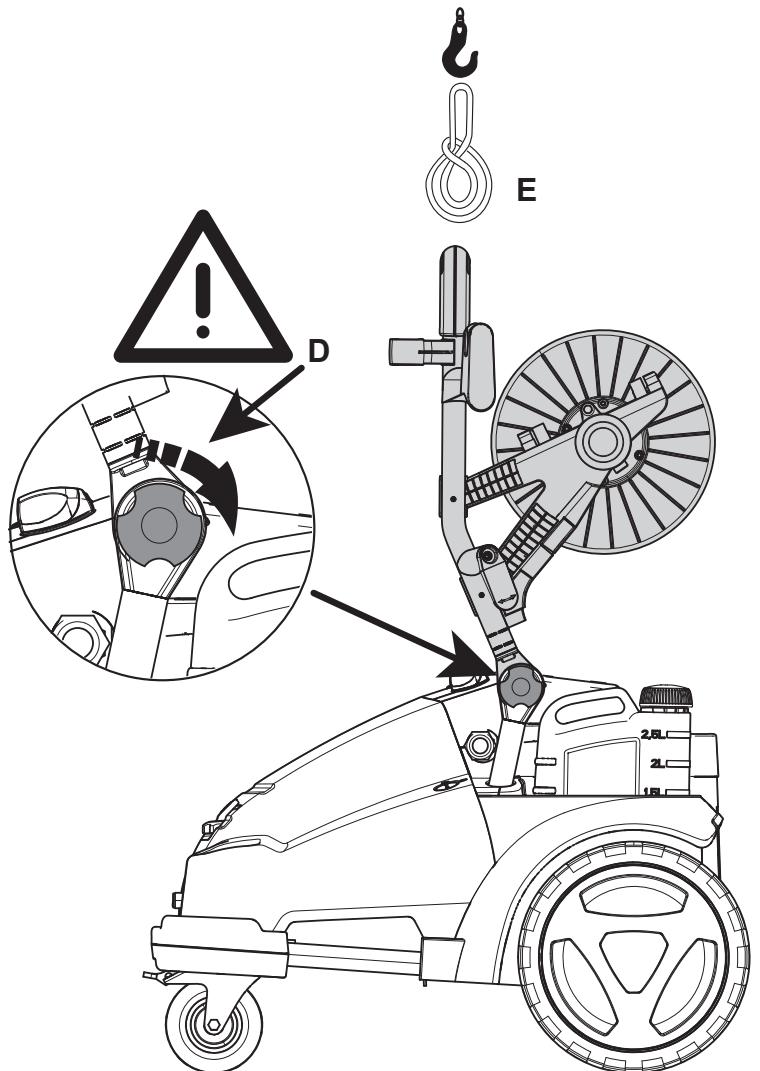

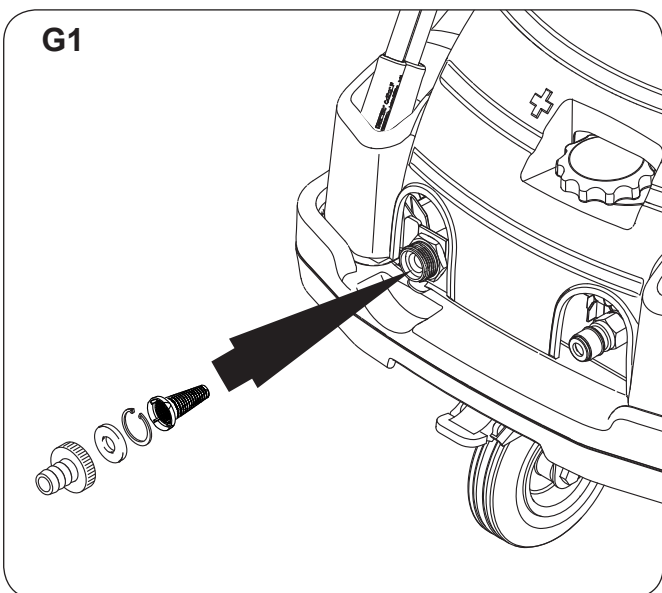
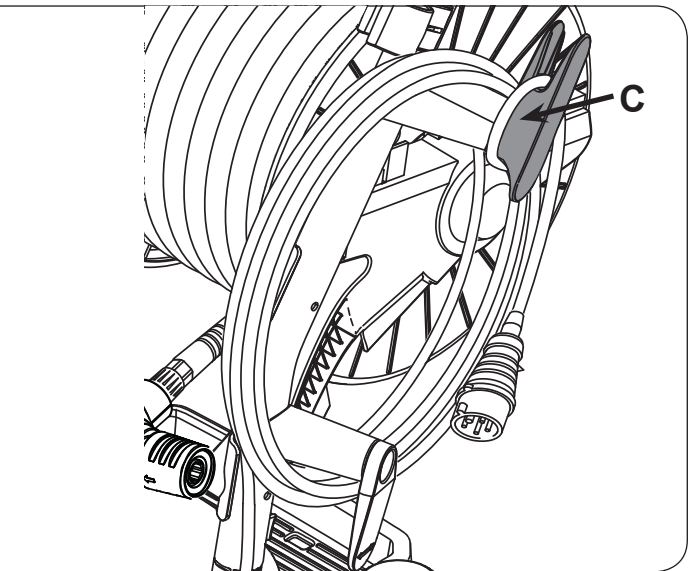
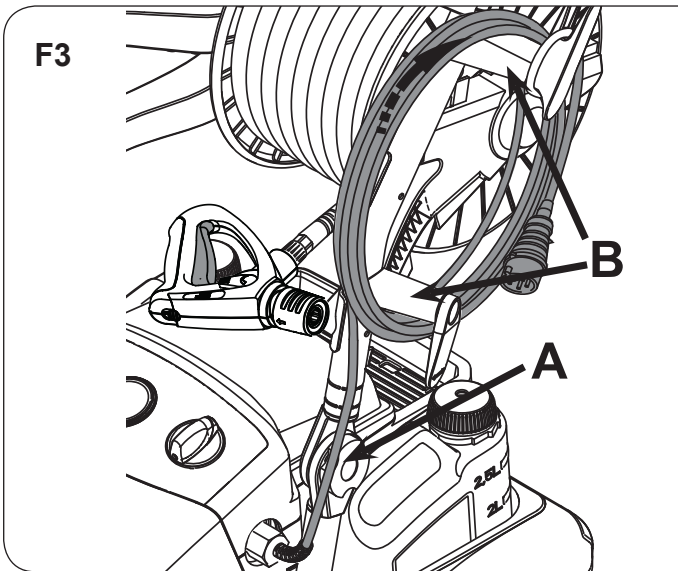
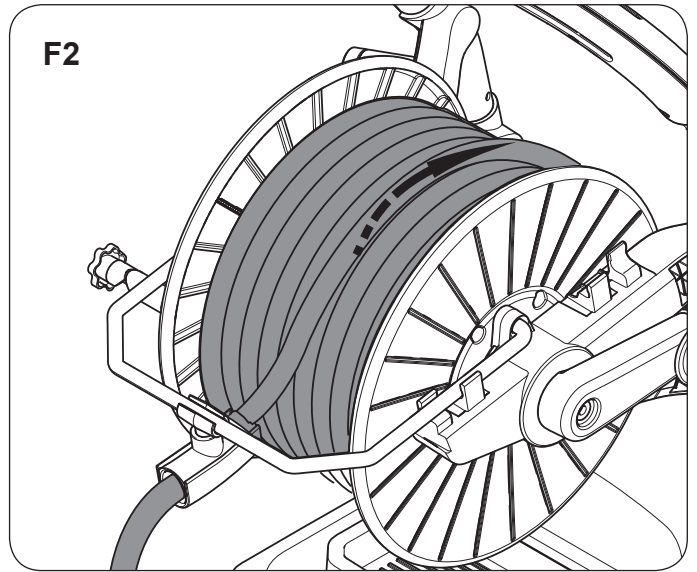
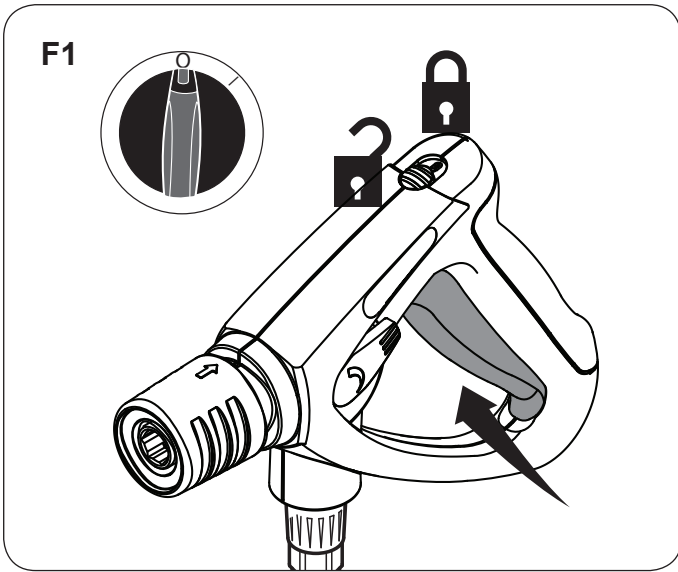

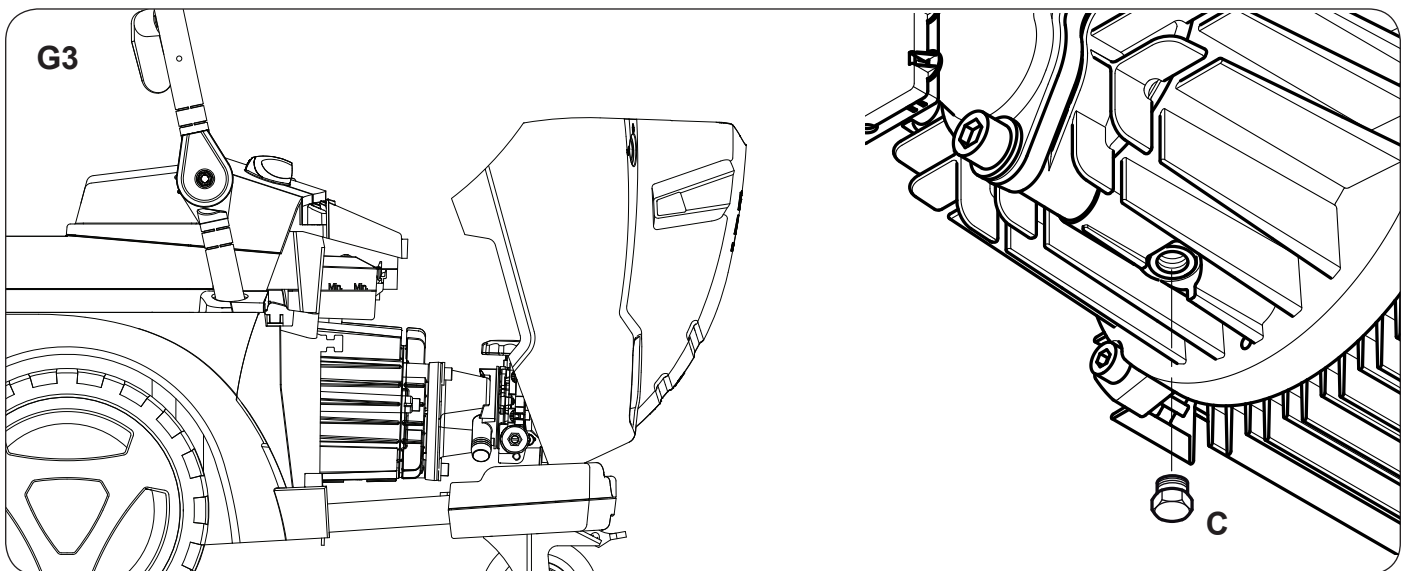
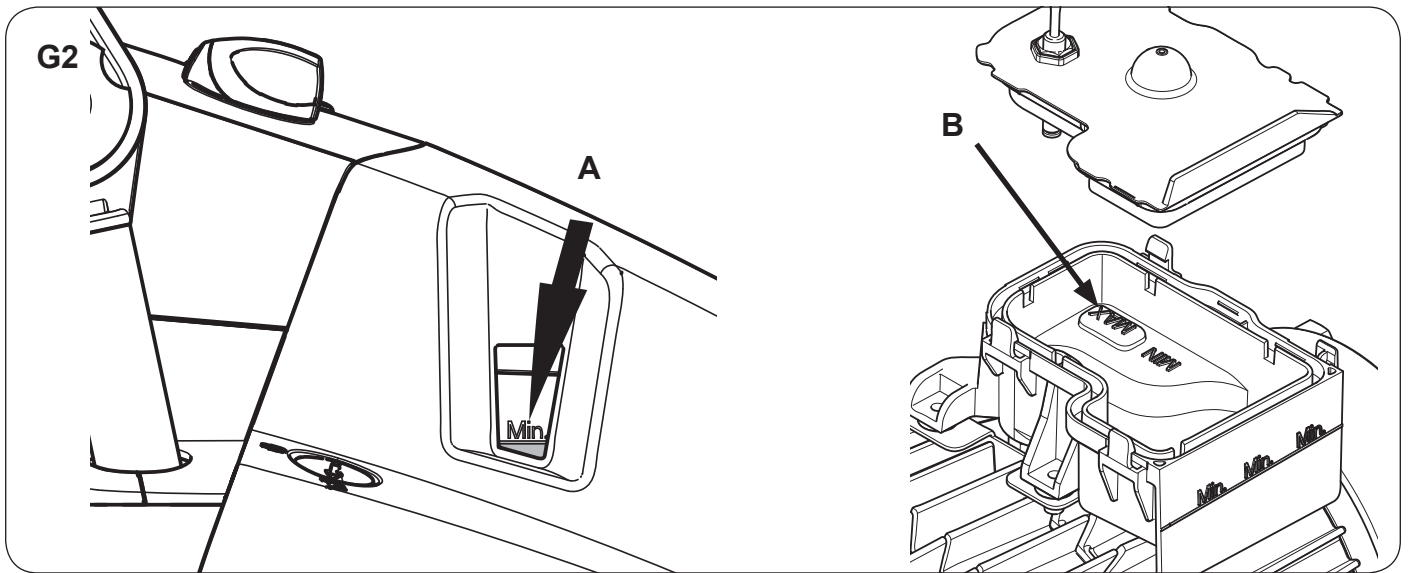

EN	Operating instructions	11
DE	Bedienungsanweisungen	15
FR	Instructions de fonctionnement	19
NL	Gebruiksaanwijzingen	23
IT	Istruzioni per l'uso	27
NO	Bruksanvisning	31
SV	Bruksanvisning	35
DA	Betjeningsvejledning	39
FI	Käyttöohje	43
ES	Instrucciones de funcionamiento	47
PT	Instruções de Funcionamento	51
EL	Οδηγίες λειτουργίας	55
TR	Kullanma Talimatları	59
SL	Navodila za delovanje	64
HR	Upute za uporabu	68
SK	Návod na obsluhu	72
CS	Návod k obsluze	76
PL	Instrukcje dotyczące obsługi	80
HU	Használati útmutató	84
RO	Instrucțiuni de utilizare.....	88
BG	Указания за експлоатация	92
RU	Руководство по эксплуатации	96
ET	Tööjuhised	100
LV	Norādījumi par ekspluatāciju	104
LT	Naudojimo instrukcija	108
ZH	操作说明.....	112
KO	사용법.....	116

Bedieningsinstructies

Deze hogedrukreiniger is ontworpen voor professionele doeleinden, voornamelijk voor de volgende reinigingstoepassingen: landbouwindustrie, transportindustrie, auto-industrie, gemeentereiniging en binnen de industrie, bouw en levensmiddelenindustrie.

De beknopte handleiding met plaatjes

De snelhandleiding met plaatjes helpt u bij het opstarten, gebruiken en opslaan van het apparaat. De handleiding is verdeeld in 8 delen.

A

LEES DE VEILIGHEIDSinSTRUCTIES VOOR GEBRUIK!

Bedieningselementen:

- A1. Duw/trekbeugel
- A2. Spuitpistool
- A3. Stroomkabel
- A4. Houder voor hogedrukslang
- A5. Hogedrukslang
- A6. Bevestigingsschroef
- A7. Lans¹⁾
- A8. Parkeerrem¹⁾
- A9. Aansluiting hogedrukslang (bij standaarduitvoeringen zonder slanghaspel)¹⁾
- A10. Wateraansluiting en waterinlaatfilter
- A11. Olieinspectieklep
- A12. Drukmeter¹⁾
- A13. Hoofdschakelaar
- A14. Detergens doseringsregeling¹⁾
- A15. Waterdoorstromingsregeling¹⁾
- A16. Detergens tank¹⁾
- A17. Afdekkap

B

Vóór de inbedrijfstelling

- B1. Voor het in bedrijf stellen van het toestel, deze controleren op eventuele schade en/of gebreken. In geval van schade dit onmiddellijk melden aan uw Nilfisk dealer. Klap de beugel omhoog en vergrendel deze in de werkstand.

VOORZICHTIG!

Het toestel nooit alleen optillen. Vraag een tweede persoon om hulp.

C

Het apparaat gereedmaken:

- C1. Het oliepeil controleren. Op een vlakke ondergrond moet de olie hoger staan dan het MIN-niveau (A) als de olie koud is.
- C2. Reinigingsmiddel tank vullen¹⁾:
 - 1. De reinigingsmiddeltank met het Nilfisk reinigingsmiddel vullen.
 - 2. Haal de reinigingsmiddelslang met filter uit het opbergvak en steek deze door de opening in de dop van de reinigingsmiddeltank
- C3. Hogedrukslang aansluiten
 - a. Toestellen zonder slanghaspel: De hogedrukslang met de snelkoppeling op de hogedrukaansluiting van het toestel aansluiten.

AANWIJZING! De maximumlengte van de hogedrukslang is 50 m.

b. Toestellen met slanghaspel:

1. Plaats de snelkoppeling van de hogedrukslang (A) op de nippel van de as.
 2. Plaats de hogedrukslang in de slanggeleider (B) en bevestig deze met de clip¹⁾.
 3. Ontkoppel de rem (C) van de slanghaspelgeleider¹⁾ en rol de hogedrukslang op.
- C4. Waterslang aansluiten:
1. De waterslang vóór de aansluiting op het toestel kort met water spoelen opdat zand en andere vuilpartikelen niet in het toestel kunnen geraken.
 2. De waterslang met de snelkoppeling op de wateraansluiting aansluiten.
 3. De waterkraan openen.
- OPMERKING! Bij water van slechte kwaliteit (zand etc.) adviseren wij om een fijn waterfilter in de machine te monteren. Max. een 50 micron filter. Wij adviseren om een versterkte waterslang met een diameter van ten minste 3/4" (19 mm) te gebruiken.
- C5. BA ventiel: Deze hogedrukreiniger mag alleen aangesloten worden op het drinkwaternet als een geschikte terugstroombeveiliging is geïnstalleerd, van type BA volgens EN 60335-2-79.
- Het BA ventiel kan worden besteld onder nummer (C: BA ventiel):
- BA ventiel inclusief GARDENA-koppelingen: 106411177
 - BA ventiel inclusief NITO-koppelingen: 106411178
 - BA ventiel inclusief GEKA-koppelingen: 106411179
 - BA ventiel zonder koppelingen: 106411184

De koppelingen kunnen worden besteld onder nummer (A: Vrouwelijke koppeling, B: Mannelijke koppeling):

- 3/4" GARDENA (A): 1608629
- 3/4" GARDENA (B): 32541
- 3/4" NITO (A): 1602945
- 3/4" NITO (B): 1600659
- 1/2" NITO (B): 1604669
- 3/4" GEKA (A): 1718
- 3/4" GEKA (B): 1311

Montagehandleiding:

1. Monteer een mannelijke koppeling op de kraan.
2. Sluit (A) aan op het BA ventiel naar de kraan.
3. Monteer een vrouwelijke koppeling op de watertoevoerslang.
4. Sluit (B) aan op het BA ventiel naar de watertoevoerslang.
5. Sluit de watertoevoerslang aan op de hogedrukreiniger.
6. Draai de kraan open en start de machine.

VOORZICHTIG!

- De terugstroombeveiliging kan verticaal of horizontaal worden gemonteerd en de aftapopening (D) moet naar beneden gericht gemonteerd worden.
- Water dat uit de aftapopening (D) stroomt, moet ongehinderd kunnen stromen.
- Indien er kans is op zand in het inlaatwater (bijv. uit uw eigen waterbron), dient er een aanvullend filter te worden geplaatst tussen de kraan en de terugstroombeveiliging.
- De lengte van de slang tussen de terugstroombeveiliging en de hogedrukreiniger moet minimaal 12 meter zijn (min. doorsnee 3/4 inch) om de mogelijke drukpieken te kunnen absorberen.
- Zodra het water door het BA-ventiel is gestroomd,

¹⁾ Speciaal toebehoren voor de verschillende uitvoeringen
Vertaling van de originele gebruiksaanwijzing

is het niet langer geschikt als drinkwater.

- Bescherm de terugstroombeveiliging tegen vorst.
- Hou de terugstroombeveiliging schoon en vrij van modder.

Onderhoud

De werking minstens een keer per jaar controleren:

1. Na de werkzaamheden de hogedrukreiniger uit zetten.
2. De tapkraan sluiten.
3. De druk in de waterslang verminderen door het spuitpistool te openen.
4. De terugstroombeveiliging demonteren. Het water moet uit de aftapopening (D) komen (max. 100 ml) om scheidings van het drinkwater te verzekeren.
5. Als dit niet het geval is, probeer dan het BA ventiel te reinigen of neem contact op met uw Nilfisk vertegenwoordiger.

C6. Elektrische aansluiting

1. Volg de veiligheidsaanwijzingen.
2. Steek de stekker in het stopcontact.

OPMERKING!

- Controleer het volgende voordat u apparaten met een spanningsregelaar aansluit: of de ingestelde spanning op de machine overeenkomt met de spanning van de elektrische installatie. Zo niet, kunnen de elektrische onderdelen van de machine defect raken¹⁾.
- Bij gebruik van een kabelhaspel: Rol de kabel volledig af.
- De hogedrukreiniger mag alleen worden aangesloten op een op de juiste wijze geïnstalleerde elektrische installatie.

C7. Loshalen van de kabel

1. Draai de kabelhaak omhoog (A).
2. Haal de kabel los (B).
3. Draai de kabelhaak terug.

D

Het apparaat inschakelen

D1. Spuitlans op spuitpistool aansluiten.

1. Trek de blauwe snelkoppeling (A) van het spuitpistool naar achteren.
2. Duw de nippel van de spuitlans (B) in de snelkoppeling en laat de koppeling (A) los.
3. De spuitlans (of ander toebehoren) naar voren trekken om te garanderen dat deze vast met het spuitpistool is verbonden.

OPMERKING! Steeds vuil van de nippel verwijderen vooraleer de spuitlans met het spuitpistool wordt verbonden.

OPMERKING! De omgevingstemperatuur moet tussen 0°C en maximaal 40°C liggen. De machinetemperatuur mag niet lager zijn dan 0°C.

D2.a Toestel inschakelen bij aansluiting op een waterleiding:

1. De hoofdschakelaar in de stand " I " brengen.
2. De spuitpistool ontgrendelen en activeren.
3. De veiligheidsrendel ook bij korte arbeidsonderbrekingen aanbrengen.

OPMERKING! Bedien het spuitpistool enkele malen kort om het systeem te ontluchten. De hogedrukreiniger schakelt automatisch uit nadat het spuitpistool is gesloten. Bedien het spuitpistool om de hogedrukreiniger weer op te starten. DSS-uitvoeringen schakelen na 20 seconden uit¹⁾.

D2.b Inschakeling van de hogedrukreiniger als deze is aangesloten op een open tank in de aanzuigmodus¹⁾ (Drukgeac-

tiveerde uitvoering)

1. Vul de slang met water voordat aanzuigset 61256 op de hogedrukreiniger wordt aangesloten.
2. Draai de hoofdschakelaar naar de stand " I ".
3. Ontgrendel het spuitpistool en bedien het.

D2.c Inschakeling van de hogedrukreiniger als deze is aangesloten op een open tank in de aanzuigmodus¹⁾ (Stroomgeactiveerde uitvoering)

1. Vul de slang met water voordat aanzuigset 61256 op de hogedrukreiniger wordt aangesloten.
2. Draai de hoofdschakelaar naar de stand " M ".
3. Ontgrendel het spuitpistool en bedien het.
4. Bedien de hoofdschakelaar opnieuw om de hogedrukreiniger weer op te starten.

OPMERKING! De hogedrukreiniger schakelt automatisch uit na vijf minuten stilstand. Zie hoofdstuk specificatie voor de max. aanzuighoogte.

D3. Drukregeling met de Tornado Pluslans en de PowerSpeedVario Pluslans:

Hoge druk = in de richting van de wijzers van de klok (+)

Lage druk = tegen de richting van de wijzers van de klok (-)

D4. Drukregeling met de FlexoPowerPlus-sproeier en de PowerSpeedVario Plus-lans: Verdraai de dop van de FlexoPowerPlus-sproeier:

Hoge druk = MAX.

Lage druk = MIN. (CHEM)

D5. Gebruik van reinigingsmiddelen: Slechts bij lage-druk-bedrijf kunnen reinigingsmiddelen worden aangezogen via de injector, die tot de standaarduitrusting behoort:

1. Verdun het reinigingsmiddel aan de hand van de aanwijzingen van de fabrikant.

2. Tornado Plus-lans en PowerSpeedVario Plus-lans¹⁾: stel de drukregeling van de spuitlans in op lage druk (-), of bij een FlexoPowerPlus-sproeier¹⁾: draai de dop van de FlexoPowerPlus-sproeier zover mogelijk richting "CHEM".

3. De hoeveelheid aangevoerd reinigingsmiddel kan worden geregeld door de meetklep te verdraaien.

4. Kies tank A door de meetklep naar de A-zijde te verdraaien. Kies tank B door de meetklep naar de B-zijde te verdraaien.

5. Hoofdschakelaar Draai de schakelaar naar de stand " I ".

6. Activeer het spuitpistool.

ATTENTIE! Reinigingsmiddelen mogen niet opdrogen. Het te reinigen oppervlak zou anders beschadigd kunnen worden!

E

Optillen met een kraan

- E1. Voordat de machine met een kraan wordt opgetild, moet deze eerst in evenwicht worden gebracht. Maak schroef (A) los, duw de beugel (B) iets naar voren.
- E2. Als de twee merktekens (C) op één lijn staan, staat de beugel in de takelstand.
- E3. Zorg ervoor dat de schroef (D) is vastgedraaid in de takelstand. Bevestig een strop rond het midden van de beugel (E) voor het vastmaken van de kraanhaak. WAARSCHUWING! Sta niet onder de machine als deze is opgetakeld.

F

Na gebruik van het apparaat of voordat u het onbeheerd achterlaat

- F1. Toestel uitschakelen:
 1. De hoofdschakelaar uitschakelen, de schakelaar in de positie "OFF".
 2. De waterkraan sluiten.
 3. De spuitpistool activeren tot het toestel drukloos is.
 4. De veiligheidsgrendel aan de spuitpistool inleggen.
 5. De waterslang van het toestel losmaken.
 6. De toestelstekker uit het stopcontact trekken.
- F2. De slang oprollen en de lans opslaan. Om ongelukken te voorkomen dient de slang altijd zorgvuldig opgerold te worden.
 1. Rol de slang op zoals afgebeeld.
 2. Plaats de spuitlans in de spuitlanshouder.
- F3. De kabel opwickelen
 1. Wikkel de kabel van voren af op over de bevestigingschroef (A) en met de klok mee rond de kabelhaken (B).
 2. Draai tot slot het uiteinde van de kabel rond de kabelvergrendeling (C).

G

Onderhoud

- G1. Waterfilter reinigen. Aan de watertoevoer is een waterfilter gemonteerd, die het binnendringen van grove vuilpartikelen in de pomp dient te verhinderen.
 1. De snelkoppeling afschroeven.
 2. De filter wegnemen en uitspoelen. De beschadigde filter vervangen.
- G2. Oliestandcontrole
 1. Het oliepeil controleren. Op een vlakke ondergrond moet de olie hoger staan dan het MIN-niveau (A) als de olie koud is.
 2. Vul eventueel olie bij. Vul tot aan het MAX-niveau (B).
- G3. Olieverversing
 1. Laat de hogedrukreiniger eerst warm worden voordat u de olie vervangt.
 2. Verwijder de kap.
 3. Draai de aftapplug (C) los en verwijder deze. De magneet van de plug moet worden schoongemaakt met een doek/servet om metalen deeltjes te verwijderen. Tap de olie af in een geschikte opvangbak (min. 1 liter) en lever de olie in overeenkomstig de voorschriften.
 4. Draai de plug op zijn plaats en vul bij met olie aan de hand van de specificaties in hoofdstuk.
 5. De olie in de olietank moet hoger staan dan het MIN-niveau op een vlakke ondergrond. Vul tot aan het MAX-niveau (B).
 6. Zet de kap weer op zijn plaats.
- G4. Controleer de kwaliteit van de pompolie. Controleer de kleur van de pompolie. Als de olie een witte kleur heeft, neem dan contact op met het onderhoudsteam van Nilfisk! **OPMERKING!** Er is een speciale oliepomp vereist als de hogedrukreiniger in de buurt van voedsel wordt gebruikt. Vraag uw Nilfisk-dealer.

Onderhoudsschema

	Wekelijks	Elke 500 bedrijfsuren	Indien nodig
Waterfilter reinigen			●
Snelkoppelingsnippels voor slang, pistool en lans smeren	●		
Oliestandcontrole	●		
Olieverversing		●	
Controleer de kwaliteit van de pompolie	●		

H

Bewaring van de machine (vorstbestendige bewaring)

Toestel in een droge, vorstbestendige ruimte opstellen: Wordt de hogedrukreiniger in een ruimte bewaard, waarin temperaturen van rond 0°C of minder optreden, moet van te voren antivriesmiddel door de pomp worden aangezogen:

1. Watertoevoerslang van het toestel losmaken.
2. Spuitlans verwijderen.
3. Toestel inschakelen, schakelstand "I". Na maximaal 3 minuten toestel uitschakelen.
4. Aanzuigslang op de watertoevoer van het toestel aansluiten en in een reservoir met antivriesmiddel steken.
5. Toestel inschakelen, schakelstand "I".
6. Spuitpistool boven het reservoir met antivriesmiddel houden en activeren om het aanzuigproces te starten.
7. Tijdens het aanzuigproces spuitpistool 2 tot 3 keer activeren.
8. Aanzuigslang uit het reservoir met het antivriesmiddel heffen en spuitpistool activeren om het resterende antivriesmiddel af te pompen.
9. Toestel uitschakelen.
10. Om elk risico te vermijden moet het toestel vóór de herinbedrijfstelling indien mogelijk in een verwarmde ruimte tijdelijk worden opgeslagen.















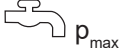
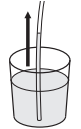

Allerlei

Machine voor recycling beschikbaar maken: Het uitgediende toestel onmiddellijk onbruikbaar maken. De netstekker uittrekken en de aansluitkabel doorknippen. Gooi elektrische toestellen nooit in het huisvuil!
Garantie:
 Voor garantie en vrijwaring gelden onze algemene handelsvoorwaarden. Veranderingen in het kader van technische vernieuwingen voorbehouden.















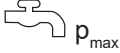
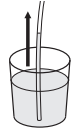

Eliminatie van storingen

Storing	Oorzaak	Eliminatie
Drukdaling	<ul style="list-style-type: none"> Lucht in het systeem HD-sproeier verstopt/versleten Reinigingsmiddeltank leeg 	<ul style="list-style-type: none"> Systeem ontlichten, daartoe spuitpistool in korte intervallen meermaals activeren, evtl. machine zonder aangesloten hogedrukslang kort in bedrijf stellen. HD-sproeier reinigen/vervangen Vul de reinigingsmiddeltank bij of stel de hoeveelheid reinigingsmiddel in op "0"
Drukschommelingen	<ul style="list-style-type: none"> Pomp zuigt lucht aan (alleen maar mogelijk in de zuigmodus) Watergebrek Watertoevoerslang te lang resp. te geringe doorsnede Watergebrek door verstopte waterfilter Watergebrek door het niet naleven van de max. toegelaten aanzuighoogte 	<ul style="list-style-type: none"> Luchtdichtheid van het zuigset controleren Waterkraan openen Gebruik een watertoevoerslang die kan voorzien in de waterdoorstroming (Qmax) die geldt voor de machine Waterfilter in de wateraansluiting reinigen (nooit zonder waterfilter werken!) Zie inbedrijfstelling
Bij het inschakelen start de motor niet	<ul style="list-style-type: none"> Stekker is niet correct ingestoken, stroomonderbreking Oliepeil te laag Netzekering is uitgeschakeld Overbelastingsbeveiliging geactiveerd wegens oververhitting of overbelasting van de motor 	<ul style="list-style-type: none"> Controleer de stekker, de kabel en de schakelaar, en laat deze eventueel vervangen door een bevoegde elektricien. Controleer oliepeil/ vul olie bij Netzekering inschakelen Laten controleren of voedende spanning en toestelspanning overeenkomen. Uitschakelen en tenminste 3 minuten laten afkoelen.
Motor bromt bij het inschakelen zonder te starten	<ul style="list-style-type: none"> Netspanning is te laag of fase-uitval Pomp is geblokkeerd of vastgevroren Verkeerde doorsnede of lengte van het verlengsnoer 	<ul style="list-style-type: none"> Elektrische aansluiting laten controleren Nilfisk klantenservice contacteren Juiste kabeldoorsnede resp. -lengte gebruiken.
Motor wordt uitgeschakeld	<ul style="list-style-type: none"> Overbelastingsbeveiliging geactiveerd wegens oververhitting of overbelasting van de motor Hogedruksproeier vuil 	<ul style="list-style-type: none"> Laten controleren of voedende spanning en toestelspanning overeenkomen. Uitschakelen en tenminste 3 minuten laten afkoelen. Hogedruksproeier vervangen
Geen reinigingsmiddelen aangevoerd	<ul style="list-style-type: none"> Tank met reinigingsmiddel leeg De dop van de FlexoPower-Plus-sproeier is niet ingesteld op lage druk De dubbele lans is niet ingesteld op lage druk De injector is vervuild of de aanzuigslang is verstopt 	<ul style="list-style-type: none"> Vul de reinigingsmiddeltank bij Instellen op lage druk Instellen op lage druk Reinigen

















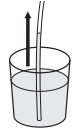

Specifications

			5M-180/840	5M-180/840 XT	5M-200/1000	5M-200/1000 XT
1			EU	EU	EU	EU
2		V/ph/Hz	400/3/50	400/3/50	400/3/50	400/3/50
3		A	16	16	16	16
4		kW кВт	4,8	4,8	6,1	6,1
5		bar (MPa) Бар (МПа) 巴 (兆帕)	180 (18)	180 (18)	200 (20)	200 (20)
6		l/h л/час 升/小时	760	760	940	940
7		bar (MPa) Бар (МПа) 巴 (兆帕)	250 (25)	250 (25)	250 (25)	250 (25)
8		l/h	840	840	1000	1000
9		°C (°F)	60 (140)	60 (140)	60 (140)	60 (140)
10		bar (MPa) Бар (МПа) 巴 (兆帕)	10 (1)	10 (1)	10 (1)	10 (1)
11		m 米	1	1	1	1
12		mm 毫米	735x570x1020	890x570x1020	735x570x1020	890x570x1020
13		kg кг	66	72	71	76
14	 $K_{PA} = 3 \text{ dB}$	dB(A) дБ(A)	75	75	76	76
15	 $K_{WA} = 3 \text{ dB}$	dB(A) дБ(A)	88	88	89	89
16	 (ISO 5349 a_h)	m/s ² 米/秒 ²	≤ 2,5	≤ 2,5	≤ 2,5	≤ 2,5
17		N	34,4	34,9	44,7	45,4
18		l 升	0,73	0,73	0,73	0,73
19			Castrol Alphasyn 150	Castrol Alphasyn 150	Castrol Alphasyn 150	Castrol Alphasyn 150

















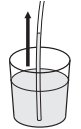

Specifications

			5M-200/1050 FA	5M-200/1050	5M-200/1050 XT	5M-220/1130 FA
1			EU	EU	EU	EU
2		V/ph/Hz	400/3/50	400/3/50	400/3/50	400/3/50
3		A	16	16	16	16
4		kW кВт	6,1	6,1	6,1	7,4
5		bar (MPa) Бар (МПа) 巴 (兆帕)	200 (20)	200 (20)	200 (20)	220 (22)
6		l/h л/час 升/小时	960	960	960	1040
7		bar (MPa) Бар (МПа) 巴 (兆帕)	250 (25)	250 (25)	250 (25)	250 (25)
8		l/h	1050	1050	1050	1130
9		°C (°F)	60 (140)	60 (140)	60 (140)	60 (140)
10		bar (MPa) Бар (МПа) 巴 (兆帕)	10 (1)	10 (1)	10 (1)	10 (1)
11		m 米	1	1	1	1
12		mm 毫米	735x570x1020	735x570x1020	890x570x1020	735x570x1020
13		kg кг	73	73	78	79
14	 $K_{PA} = 3 \text{ dB}$	dB(A) дБ(A)	76	76	76	75
15	 $K_{WA} = 3 \text{ dB}$	dB(A) дБ(A)	89	89	89	88
16	 (ISO 5349 a_h)	m/s ² 米/秒 ²	≤ 2,5	≤ 2,5	≤ 2,5	≤ 2,5
17		N	46	46	46,5	52,8
18		l 升	0,73	0,73	0,73	0,73
19			Castrol Alphasyn 150	Castrol Alphasyn 150	Castrol Alphasyn 150	Castrol Alphasyn 150

















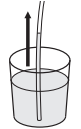

Specifications

			5M-220/1130	5M-220/1130 XT	5M-200/1050	5M-200/1050 XT
1			EU	EU	NO,BE	NO,BE
2		V/ph/Hz	400/3/50	400/3/50	230-400/ 3/50	230-400/ 3/50
3		A	16	16	25	25
4		kW кВт	7,4	7,4	6,1	6,1
5		bar (MPa) Бар (МПа) 巴 (兆帕)	220 (22)	220 (22)	200 (20)	200 (20)
6		l/h л/час 升/小时	1040	1040	960	960
7		bar (MPa) Бар (МПа) 巴 (兆帕)	250 (25)	250 (25)	250 (25)	250 (25)
8		l/h	1130	1130	1050	1050
9		°C (°F)	60 (140)	60 (140)	60 (140)	60 (140)
10		bar (MPa) Бар (МПа) 巴 (兆帕)	10 (1)	10 (1)	10 (1)	10 (1)
11		m 米	1	1	1	1
12		mm 毫米	735x570x1020	890x570x1020	735x570x1020	890x570x1020
13		kg кг	78	85	75	80
14	 $K_{PA} = 3 \text{ dB}$	dB(A) дБ(A)	75	75	76	76
15	 $K_{WA} = 3 \text{ dB}$	dB(A) дБ(A)	88	88	89	89
16	 (ISO 5349 a_h)	m/s ² 米/秒 ²	≤ 2,5	≤ 2,5	≤ 2,5	≤ 2,5
17		N	52,8	54	46	46,5
18		l 升	0,73	0,73	0,73	0,73
19			Castrol Alphasyn 150	Castrol Alphasyn 150	Castrol Alphasyn 150	Castrol Alphasyn 150

















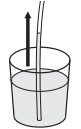

Specifications

			5M-100/770	5M-100/770 XT	5M-200/1050	5M-220/1130
1			UK	UK	EXP	EXP
2		V/ph/Hz	230/1/50	230/1/50	220-440/ 3/60	220-440/ 3/60
3		A	13	13	20	30
4		kW кВт	2,9	2,9	6,1	7
5		bar (MPa) Бар (МПа) 巴 (兆帕)	100 (10)	100 (10)	200 (20)	220 (22)
6		l/h л/час 升/小时	700	700	960	1040
7		bar (MPa) Бар (МПа) 巴 (兆帕)	150 (15)	150 (15)	250 (25)	250 (25)
8		l/h	770	770	1050	1130
9		°C (°F)	60 (140)	60 (140)	60 (140)	60 (140)
10		bar (MPa) Бар (МПа) 巴 (兆帕)	10 (1)	10 (1)	10 (1)	10 (1)
11		m 米	1	1	1	1
12		mm 毫米	735x570x1020	890x570x1020	735x570x1020	735x570x1020
13		kg кг	68	73	74	80
14	 $K_{PA} = 3 \text{ dB}$	dB(A) дБ(A)	68	68	76	75
15	 $K_{WA} = 3 \text{ dB}$	dB(A) дБ(A)	82	82	89	88
16	 (ISO 5349 a_h)	m/s ² 米/秒 ²	≤ 2,5	≤ 2,5	≤ 2,5	≤ 2,5
17		N	23,5	23,7	45,6	52,8
18		l 升	0,73	0,73	0,73	0,73
19			Castrol Alphasyn 150	Castrol Alphasyn 150	Castrol Alphasyn 150	Castrol Alphasyn 150















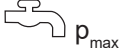
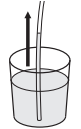

Specifications

			5M-115/700	5M-200/1030	6P-250/1100 FA	6P-250/1100 FA
1			AU	AU	EU	EXP
2		V/ph/Hz	240/1/50	415/3/50	400/3/50	220-440/ 3/60
3		A	15	20	16	30
4		kW кВт	3	6,1	8,5	8,5
5		bar (MPa) Бар (МПа) 巴 (兆帕)	115(11,5)	200(20)	250 (25)	250 (25)
6		l/h л/час 升/小时	630	950	1000	1000
7		bar (MPa) Бар (МПа) 巴 (兆帕)	172,5(17,25)	250(25)	250 (25)	250 (25)
8		l/h	700	1030	1100	1100
9		°C (°F)	60(140)	60(140)	80 (176)	80 (176)
10		bar (MPa) Бар (МПа) 巴 (兆帕)	10 (1)	10 (1)	10 (1)	10 (1)
11		m 米	1	1	1	1
12		mm 毫米	735x570x1020	735x570x1020	775x570x1020	775x570x1020
13		kg кг	68	73	89	89
14	 $K_{PA} = 3 \text{ dB}$	dB(A) дБ(A)	68	76	80	80
15	 $K_{WA} = 3 \text{ dB}$	dB(A) дБ(A)	82	89	93	93
16	 (ISO 5349 a_h)	m/s ² 米/秒 ²	≤ 2,5	≤ 2,5	≤ 2,5	≤ 2,5
17		N	22,8	46,4	54,1	57,2
18		l 升	0,73	0,73	0,95	0,95
19			Castrol Alphasyn T 150	Castrol Alphasyn T 150	Castrol Alphasyn 150	Castrol Alphasyn 150

















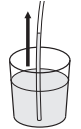

Specifications

			6P-180/1300 FA	6P-180/1300 FA	6P-170/1600 FA	6P-250/1100 FAXT
1			EU	EXP	EU	EU
2		V/ph/Hz	400/3/50	220-440/ 3/60	400/3/50	400/3/50
3		A	16	30	16	16
4		kW кВт	7,4	8,2	8,8	8,8
5		bar (MPa) Бар (МПа) 巴 (兆帕)	180 (18)	180 (18)	170 (17)	250 (25)
6		l/h л/час 升/小时	1200	1200	1500	1000
7		bar (MPa) Бар (МПа) 巴 (兆帕)	250 (25)	250 (25)	250 (25)	250 (25)
8		l/h	1300	1300	1600	1100
9		°C (°F)	80 (176)	80 (176)	80 (176)	80 (176)
10		bar (MPa) Бар (МПа) 巴 (兆帕)	10 (1)	10 (1)	10 (1)	10 (1)
11		m 米	1	1	1	1
12		mm 毫米	775x570x1020	775x570x1020	775x570x1020	930x570x1020
13		kg кг	86	87	89	96
14	 $K_{PA} = 3 \text{ dB}$	dB(A) дБ(A)	77	77	77	80
15	 $K_{WA} = 3 \text{ dB}$	dB(A) дБ(A)	90	90	90	93
16	 (ISO 5349 a_h)	m/s ² 米/秒 ²	≤ 2,5	≤ 2,5	≤ 2,5	≤ 2,5
17		N	56,4	58	68,2	54,6
18		l 升	0,95	0,95	0,95	0,95
19			Castrol Alphasyn 150	Castrol Alphasyn 150	Castrol Alphasyn 150	Castrol Alphasyn 150

















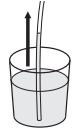

Specifications

			6P-180/1300 FAXT	6P-180/1300 FAXT	6P-170/1600 FAXT	6P-200/1100 FAXT
1			EU	NO,BE	EU	EU
2		V/ph/Hz	400/3/50	230-400/3/50	400/3/50	400/3/50
3		A	16	25	16	16
4		kW кВт	7,7	7,7	9	7,3
5		bar (MPa) Бар (МПа) 巴 (兆帕)	180 (18)	180 (18)	170 (17)	200 (20)
6		l/h л/час 升/小时	1200	1200	1500	1000
7		bar (MPa) Бар (МПа) 巴 (兆帕)	250 (25)	250 (25)	250 (25)	250 (25)
8		l/h	1300	1300	1600	1100
9		°C (°F)	80 (176)	80 (176)	80 (176)	80 (176)
10		bar (MPa) Бар (МПа) 巴 (兆帕)	10 (1)	10 (1)	10 (1)	10 (1)
11		m 米	1	1	1	1
12		mm 毫米	930x570x1020	930x570x1020	930x570x1020	930x570x1020
13		kg кг	93	93	96	85
14	 $K_{PA} = 3 \text{ dB}$	dB(A) дБ(A)	77	77	77	75
15	 $K_{WA} = 3 \text{ dB}$	dB(A) дБ(A)	90	90	90	88
16	 (ISO 5349 a_h)	m/s ² 米/秒 ²	≤ 2,5	≤ 2,5	≤ 2,5	≤ 2,5
17		N	57,4	57,4	68,9	52,2
18		l 升	0,95	0,95	0,95	0,95
19			Castrol Alphasyn 150	Castrol Alphasyn 150	Castrol Alphasyn 150	Castrol Alphasyn 150





Specifications





			6P-250/1100 FA	7P-195/1280 FA	7P-195/1280 FAXT	7P-195/1280 FA
1			AU	EU,DK	EU	NO, BE
2		V/ph/Hz	415/3/50	400/3/50	400/3/50	230-400/3/50
3		A	20	16	16	25
4		kW кВт	8,5	8	8	8
5		bar (MPa) Бар (МПа) 巴 (兆帕)	250 (25)	195 (19,5)	195 (19,5)	195 (19,5)
6		l/h л/час 升/小时	1000	1180	1180	1180
7		bar (MPa) Бар (МПа) 巴 (兆帕)	250 (25)	250 (25)	250 (25)	250 (25)
8		l/h	1100	1280	1280	1280
9		°C (°F)	80 (176)	85 (185)	85 (185)	85 (185)
10		bar (MPa) Бар (МПа) 巴 (兆帕)	10 (1)	10 (1)	10 (1)	10 (1)
11		m 米	1	1	1	1
12		mm 毫米	775x570x1020	775x570x1020	930x570x1020	775x570x1020
13		kg кг	89	89	95	90
14	 $K_{PA} = 3 \text{ dB}$	dB(A) дБ(A)	80	75	75	76
15	 $K_{WA} = 3 \text{ dB}$	dB(A) дБ(A)	93	88	88	89
16	 (ISO 5349 a_h)	m/s ² 米/秒 ²	≤ 2,5	≤ 2,5	≤ 2,5	≤ 2,5
17		N	54,1	57,8	58,6	57,8
18		l 升	0,95	1,1	1,1	1,1
19			Castrol Alphasyn T 150	Castrol Alphasyn 150	Castrol Alphasyn 150	Castrol Alphasyn 150



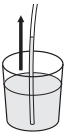

Specifications

			7P-195/1280 FA	7P-195/1280 FA
1			EXP	AU
2		V/ph/Hz	220-440/3/60	415/3/50
3		A	30	20
4		kW кВт	8	8
5		bar (MPa) Бар (МПа) 巴 (兆帕)	195 (19,5)	195(19,5)
6		l/h л/час 升/小时	1180	1180
7		bar (MPa) Бар (МПа) 巴 (兆帕)	250 (25)	250(25)
8		l/h	1280	1280
9		°C (°F)	85 (185)	85(185)
10		bar (MPa) Бар (МПа) 巴 (兆帕)	10 (1)	10 (1)
11		m 米	1	1
12		mm 毫米	775x570x1020	775x570x1020
13		kg кг	93	89
14	 $K_{PA} = 3 \text{ dB}$	dB(A) дБ(A)	75	75
15	 $K_{WA} = 3 \text{ dB}$	dB(A) дБ(A)	88	88
16	 (ISO 5349 a_h)	m/s ² 米/秒 ²	≤ 2,5	≤ 2,5
17		N	60	57,8
18		l 升	1,1	1,1
19			Castrol Alphasyn 150	Castrol Alphasyn T 150

1			EN: Country variant. DE: Ländervarianten. FR: Selon le pays. NL: Nationale variant. IT: Variante per il Paese. NO: Variant i ulike land. SV: Landsvariant. DA: Landespecifik variant. FI: Maakohmainen vaihtelu. ES: Dependé del país. PT: Variante do país. EL: Έκδοση χώρας. TR: Ülke-deki model. SL: Jezikovna različica. HR: Ovisno o zemlji. SK: Vrsta ulja. CS: Varianta země. PL: Wersja dla kraju. HU: Országfüggő modellváltozatok. RO: Varianta țării. BG: Вариант за страната. RU: Региональное исполнение. ET: Riigi variant. LV: Valsts versija. LT: Šaliai skirtas variantas. JA: 国による相違。 ZH: 不同国家 KO: 국가별 모델. TH: แตกต่างกันไปตามประเทศ MS: Variasi negara.
2		V/ph/Hz	EN: Possible voltage. DE: Mögliche Spannung. FR: Tension autorisée. NL: Mogelijke spanning. IT: Possibile voltaggio. NO: Mulig spenning. SV: Möjlig spänning. DA: Spænding. FI: Mahdollinen jännite, V/vaiheluku/taajuus. ES: Tensión admitida. PT: Tensão possível. EL: Πιθανή τάση, V/ph/Frez. TR: Olası voltaj, V/Faz/Frekans. SL: Morebitna napetost. HR: Mogući napon. SK: Možné napätie. CS: Možné napětí. PL: Dopuszczalne napięcie, V/fazy/częst. HU: Tápészültség, V/fázis/frekv. RO: Tensiune posibilă, V/fază/Frecv. BG: Възможно напрежение. RU: Напряжение, В/φ./част. В/φ./Гц. ET: Võimalik pinge, V/faas/sagedus. LV: iespējamais spriegums. LT: Galima įtampa V / F / Frez. JA: 電圧。 ZH: 可能电压 (V / ph / Fréz) KO: 허용 전압, 볼트/상/헤르츠. TH: แรงดันไฟฟ้าที่สามารถใช้ได้ MS: Kemungkinan voltan.
3		A	EN: Fuse. DE: Sicherung. FR: Fusible. NL: Zekering. IT: Fusibile. NO: Sikring. SV: Säkring. DA: Sikring. FI: Sulake. ES: Fusible. PT: Fusível. EL: Ασφάλεια. TR: Sigorta. SL: Varovalka. HR: Osigurač. SK: Poistka. CS: Pojistka. PL: Bezpiecznik. HU: Biztosíték. RO: Siguranță. BG: Предпазител. RU: Предохранитель. ET: Kaitse. LV: Drošinātājs. LT: Saugiklis. JA: ヒューズ. ZH: 保险丝. KO: 퓨즈. TH: ฟิวส์. MS: Fius.
4		kW кВт	EN: Power rating. DE: Nennleistung. FR: Puissance nominale. NL: Nominiaal vermogen. IT: Corrente nominale. NO: Nominell effekt. SV: Märkeffekt. DA: Nominel effekt. FI: Tehontarve. ES: Potencia nominal. PT: Classificação de potência. EL: Ονομαστική ισχύς. TR: Elektrik değeri. SL: Moč. HR: Oznaka napona. SK: Stanovenie výkonu. CS: Jmenovitý výkon. PL: Moc znamionowa. HU: Névleges teljesítmény. RO: Putere nominală. BG: Мощност. RU: Номинальная мощность кВт. ET: Vooluühik. LV: Nominālā jauda. LT: Galia. JA: 定格電力。 ZH: 额定功率. KO: 전원 등급. TH: อัตรากำลังไฟ. MS: Penarafan kuasa.
5		bar (MPa) Бар (МПа) 巴 (兆帕)	EN: Working pressure. DE: Arbeitsdruck. FR: Pression de service. NL: Werkdruk. IT: Pressione di esercizio. NO: Arbeidstrykk. SV: Arbetstryck. DA: Arbejdstryk. FI: Työpaine. ES: Presión de trabajo. PT: Pressão de trabalho. EL: Πίεση λειτουργίας. TR: Çalışma basıncı. SL: Delovni tlak. HR: Radni tlak. SK: Pracovný tlak. CS: Provozní tlak. PL: Ciśnienie robocze. HU: Üzemi nyomás. RO: Presiune de lucru. BG: Работно налягане. RU: Рабочее давление. ET: Töösurve. LV: Darba spiediens. LT: Darbinis slėgis. JA: 動作圧力。 ZH: 工作压力. KO: 작업 압력. TH: แรงดันขณะใช้งาน. MS: Tekanan kerja.
6		l/h л/час 升/小时	EN: Water flow. DE: Wasserdurchsatz. FR: Débit d'eau. NL: Waterdoorstroming. IT: Flusso dell'acqua. NO: Vanntilførsel. SV: Vattenflöde. DA: Vandmængde. FI: Vedenvirtaus. ES: Flujo de agua. PT: Fluxo de água. EL: Ροή νερού. TR: Su akışı. SL: Pretok vode. HR: Regulacija protoka vode. SK: Prietok vody. CS: Průtok vody. PL: Przepływ wody. HU: Vízfolyás. RO: Debit apă. BG: Воден поток. RU: Расход воды. ET: Veevool. LV: Ūdens plūsma. LT: Vandens srautas. JA: 流水. ZH: 水流量. KO: 급수량. TH: การไหลของน้ำ. MS: Aliran air.

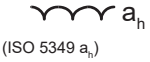
7		bar (MPa) Бар (МПа) 巴 (兆帕)	<p>EN: Max. water pressure. DE: Max Wasserdruck. FR: Pression d'eau maximale. NL: Max. waterdruk. IT: Max. pressione dell'acqua. NO: Maks. vanntrykk. SV: Max vattentryck. DA: Max. vandtryk. FI: Suurin vedenpaine. ES: Presión máxima de entrada del agua. PT: Pressão máxima de água. EL: Μέγ. πίεση νερού. TR: Maks. su basıncı. SL: Najv. vodni tlak. HR: Maksimalni tlak vode. SK: Maximálny tlak vody. CS: Max. tlak vody. PL: Maks. ciśnienie wody. HU: Max. víznyomás. RO: Presiune max. apă. BG: Макс. налягане на водата. RU: Макс. давление воды. ET: Max veesurve. LV: Maks. ūdens spiediens. LT: Maks. vandens slėgis. JA: 最高水圧 ZH: 最大水圧 KO: 최대 수압. TH: ความดันน้ำสูงสุด MS: Tekanan air maksimum.</p>
8		l/h	<p>EN: Water flow DE: Wasserdurchsatz. FR: Débit d'eau. NL: Waterdoorstroming. IT: Flusso dell'acqua. NO: Vanntilførsel. SV: Vattenflöde. DA: Vandmængde. FI: Vedevirtaus. ES: Flujo de agua. PT: Fluxo de água. EL: Ποή νερού. TR: Su akışı. SL: Pretok vode. HR: Protok vode. SK: Prietok vody. CS: Průtok vody. PL: Przepływ wody. HU: Vízfolyás. RO: Debit apă. BG: Воден поток. RU: Расход воды. ET: Veevool. LV: Ūdens plūsma. LT: Vandens srautas. JA: 流水. ZH: 水流量 KO: 급수량. TH: การไหลของน้ำ MS: Aliran air.</p>
9		°C (°F)	<p>EN: Max water inlet temperature, Intake-Pressure operation. DE: Max Wassereinlasstemperatur - Druckbetrieb. FR: Température max. de l'entrée d'eau en mode admission/pression. NL: Max. Waterinlaattemperatuur Inlaat-Tijdens. Bedrijf. IT: Temperatura max. alimentazione acqua Funzionamento a ingressopressione. NO: Maks. temperatur vanninntak, Inntakstrykk drift. SV: Max ingående vattentemperatur inlopps-tryckdrift. DA: Maks. vandtilgangstemperatur, tilgangstrykdrift. FI: Tuloveden suurin lämpötila, käytettäessä painepesurina. ES: Temperatura y presión máxima de entrada del agua. PT: Temperatura máxima de entrada de água, Funcionamento da pressão de entrada. EL: Μεγ. θερμοκρασία εισόδου νερού-λειτουργίας πίεσης. TR: Maks. su girişi sıcaklığı Emme-Basınçlı çalışma. SL: Najv. vstopna temperatura vode, vstopni tlak pri delovanju. HR: Maks. temperatura ulazne vode, tlak pri usisavanju. SK: Max. vstupná teplota vody, Prevádzka v nasávacom režime pod tlakom. CS: Max. teplota vody na vstupu, provozní sací tlak. PL: Maks. temperatura na dopływie wody z instalacji wodociągowej. HU: Max. bemenő vízhőmérséklet Szívónyomásos üzem. RO: Temperatura max. de admisie apă în cazul alimentării de la robinet. BG: Макс. температура на входящата вода – работа в режим на засмукване. RU: Макс. температура воды на входе (всасывание/подача под давлением). ET: Max vee sisselasketemperatuur Sissevoturõhk töö ajal. LV: Maks. ūdens ieplūdes temperatūra ieplūdes-spiediena darbībā. LT: Didžiausia vandens paėmimo temperatūra, veikimas esant įėjimo slėgiui. JA: 最高流入水温度、吸気圧力動作. ZH: 进水压力操作时的最高进水水温 KO: 최대 급수 온도 주입/압력 작동. TH: อุณหภูมิน้ำเข้าสูงสุด ความดันในการใช้งานบริเวณทางเข้า MS: Suhu maksimum air masuk, Kemasukan-Operasi tekanan.</p>
10		bar (MPa) Бар (МПа) 巴 (兆帕)	<p>EN: Max. water inlet pressure. DE: Max. Wassereinlassdruck. FR: d'eau en mode admission/pression. NL: Max. waterinlaatdruk. IT: Pressione max. alimentazione acqua. NO: Maks. trykk vanninntak. SV: Max tryck för vatteninlopp. DA: Maks. Vandtilgangstryk. FI: Tuloveden suurin paine. ES: Presión máxima de entrada del agua. PT: Pressão máxima de entrada de água. EL: Μέγ. πίεση εισόδου νερού. TR: Maks. su girişi basıncı. SL: Najv. tlak dovoda vode. HR: Maks. tlak ulazne vode. SK: Max. vstupný tlak vody. CS: Max. tlak vody na vstupu. PL: Maks. ciśnienie na dopływie wody. HU: Max. bemenő nyomás. RO: Presiunea max. de alimentare cu apă. BG: Макс. налягане на входяща вода. RU: Макс. давление воды на входе. ET: Maks vee sissevoolusurve. LV: Maks. ūdens spiediens. LT: Didžiausias vandens paėmimo slėgis. JA: 最高流入水圧. ZH: 最大进水压力 KO: 최고 급수 압력. TH: ความดันน้ำเข้าสูงสุด MS: Tekanan maksimum air masuk.</p>

11		m 米	<p>EN: Max dry suction height. DE: Max. Trockensaughöhe. FR: Hauteur d'aspiration à sec max. NL: Max. droge aanzuighoogte. IT: Altezza massima di aspirazione secco. NO: Maks. sugehøyde tørr. SV: Max torr-sugningshöjd. DA: Maks. sugehøjde, tør. FI: Suurin kuivaimukorkeus. ES: Altura máxima de succión en seco. PT: Altura de aspiração a seco máx. EL: Μέγ. ύψος αναρρόφησης. TR: Maks. Kuru emme yüksekliği. SL: Najv. višina suhega vsesavanja. HR: Maks. visina pri suhom usisavanju. SK: Max. suchá nasávacia výška. CS: Max. sací výška nasucho. PL: Maks. wysokość ssania na sucho. HU: Max. száraz szívómagasság. RO: Înălțime max. de aspirare în cazul alimentării cu apă dintr-un recipient. BG: Макс. височина на сухо засмукване. RU: Макс. высота всасывания. ET: Max kuivimu kõrgus. LV: Maks. sausās sūkšanas augstums. LT: Maksimalus sausas įsiurbimo aukštis. JA: 最大乾燥吸込高さ。 ZH: 最大干吸高度 米 KO: 최대 건조 흡입 높이. TH: ความสูงของท่อดูดแห้งสูงสุด MS: Ketinggian maksimum sedutan kering.</p>
12		mm 毫米	<p>EN: Dimensions LxWxH. DE: Masse LxBxH. FR: Dimensions l x p x h. NL: Afmetingen LxBxH. IT: Dimensioni, lun. x larg. x alt. NO: Mål LxBxH. SV: Dimensioner LxBxH. DA: Mål LxBxH. FI: Mitat, PxLxK. ES: Dimensiones l x a x al. PT: Dimensões, C x L x A. EL: Διαστάσεις, Μ x Π x Υ. TR: Boyutlar, u x g x y. SL: Mere D x Š x V. HR: Dimenzije DxŠxV. SK: Rozmery D x Š x V. CS: Rozměry d x š x v. PL: Wymiary długość x szer. x wys. HU: Méretek H x Sz x M. RO: Dimensiuni. L x l x î. BG: Размери Д x Ш x В. RU: Размеры, Дл. x Шир. x Выс. ET: Mõõtmed p x l x k. LV: Izmēri G x P x A. LT: Matmenys (i x p x a). JA: 外形寸法長さx幅x高さ。 ZH: 尺寸 (长x宽x高) 毫米 KO: 크기(l x w x h). TH: ขนาด ยาว x กว้าง x สูง MS: Dimensi LxWxH.</p>
13		kg кг	<p>EN: Weight. DE: Gewicht. FR: Poids du nettoyeur. NL: Gewicht van de hogedrukreiniger. IT: Peso dell'idropulitrice. NO: Vekt høytrykksvasker. SV: Maskinens vikt. DA: Vægt. FI: Pelkän painepesurin paino. ES: Peso del limpiador. PT: Peso da máquina de limpeza. EL: Βάρος μηχανήματος καθαρισμού. TR: Temizlik makinesinin yüksekliği. SL: Masa. HR: Težina. SK: Hmotnosť. CS: Hmotnost čisticího stroje. PL: Ciężar myjki. HU: Tisztítógép tömege. RO: Greutatea aparatului. BG: Тегло. RU: Вес моющей машины. ET: Pesuri kaal. LV: Tīrītāja svars. LT: Valymo įrenginio svoris. JA: 重量。 ZH: 清洗机重量 KO: 세척기 무게. TH: น้ำหนัก MS: Berat.</p>
14	 $K_{PA} = 3 \text{ dB}$	dB(A) дБ(А)	<p>EN: Sound pressure level L_{PA}. DE: Schalldruckpegel FR: Niveau de pression acoustique NL: Geluidsdrukniveau IT: Livello pressione sonora NO: Lydtrykknivå SV: Ljudtrycksnivå DA: Lydtryksniveau FI: Äänenpainetaso ES: Nivel de presión sonora PT: Nível de pressão acústica EL: Επίπεδο πίεσης ήχου TR: Göre ses basıncı seviyesi SL: Raven zvočnega tlaka. HR: Razina zvučnog tlaka. SK: Hladina zvukového. CS: Hladina akustického tlaku PL: Poziom ciśnienia akustycznego HU: Hangnyomásszint RO: Nivel de presiune acustică BG: Ниво на звуково налягане RU: Уровень шума ET: Helisurve tase LV: Akustiskā spiediena līmenis LT: Garso slėgio lygis JA: 音圧レベル ZH: 声压级 KO: 음압 레벨 TH: ระดับความดันเสียง MS: Tahap tekanan bunyi</p>
15	 $K_{WA} = 3 \text{ dB}$	dB(A) дБ(А)	<p>EN: Sound power level L_{WA}. DE: Schallleistungspegel FR: Niveau de puissance acoustique NL: Geluidsvermogeniveau IT: Livello potenza sonora NO: Lydeffektnivå SV: Ljudeffektnivå DA: Lydeffektniveau FI: Äänen tehotaso ES: Potencia acústica PT: Nível de potência acústica EL: Επίπεδο ισχύος ήχου TR: Göre ses basıncı seviyesi SL: Raven moči zvoka. HR: Razina jakosti. SK: Hladina zvukového výkonu. CS: Hladina akustického výkonu PL: Poziom mocy akustycznej HU: Hangteljesítmény szint RO: Nivelul de putere acustică BG: Ниво на звукова мощност RU: Уровень звуковой мощности ET: Helivõimsuse tase LV: Akustiskās jaudas līmenis LT: Garso galios lygis JA: 音響パワーレベル ZH: 声功率级 KO: 소음 레벨 TH: ระดับกำลังเสียง MS: Tahap kuasa bunyi</p>

16a		m/s^2 米/秒 ²	EN: Vibration. DE: Vibrationen FR: Vibration NL: Vibratie IT: Vibrazioni NO: Vibrasjoner SV: Vibration DA: Vibration FI: Tärinäarvot ES: Vibración PT: Vibração EL: Δόνηση TR: Titreşimi SL: Vibracije. HR: Vibracije. SK: Vibrácie. CS: Vibrace PL: Drgania HU: Vibráció RO: Vibrații BG: Вибрации. RU: Вибрация ET: vibratsioon LV: vibrācija LT: Vibracijos JA: 振動。 ZH: 振动 KO: 진동 TH: แรงสั่นสะเทือน MS: Getaran.
17		N	EN: Recoil forces, lance. DE: Rückstoßkraft, Sprühhrohr FR: Forces de recul, lance NL: Terugslagkracht, lans IT: Forze di rinculo, lancia NO: Rekylkraft, lanse SV: Rekylkraft, spolrör DA: Rekylkraft, dyserør FI: Rekyylivoimat, suutin ES: Fuerzas de retroceso, lanza PT: Forças de retrocesso, lança EL: Δυνάμεις οπισθοδρόμησης, διάταξη ψεκασμού χη. TR: Sarmal kuvvetler, boru SL: Povratne sile, šoba. HR: Trzajne sile, mlaznica. SK: Spätný odraz, štandardná striekacia rúra. CS: Síly zpětného rázu, násadec PL: Siły odrzutu, lanca HU: Visszaható erő, szórócső RO: Forțe de recul, tija BG: Сили на откат, накрайник. RU: Сила отдачи (распылитель). ET: Tagasilöögijõud, otsik LV: Atsitiena spēks, smidzinātājs LT: Atatrankos jėga, antgalis JA: 反跳力、ランス。 ZH: 反冲力 (喷杆) KO: 반동력, 랜스 TH: แรงสะท้อนถอยหลัง, ป้ายทอ MS: Kuasa sentakan, lans.
18		l 升	EN: Oil quantity. DE: Ölmenge. FR: Quantité d'huile. NL: Hoeveelheid olie. IT: Quantità olio. NO: Oljemengde. SV: Oljemängd. DA: Oliemængde. FI: Öljymäärä. ES: Cantidad de aceite. PT: Quantidade de óleo. EL: Ποσότητα λαδιού. TR: Yağ miktarı. SL: Količina olja. HR: Količina ulja. SK: Množstvo oleja. CS: Množství oleje. PL: Objętość oleju. HU: Olajmennyiség. RO: Cantitate de ulei. BG: Количество на маслото. RU: Количество масла. ET: Õli kogus. LV: Eļļas daudzums. LT: Tepalo kiekis. JA: オイル量。 ZH: 油量升 KO: 오일량 TH: ปริมาณน้ำมัน MS: Kuantiti minyak.
19			EN: Oil type. DE: Öltyp. FR: Type d'huile. NL: Olietype. IT: Tipo olio. NO: Oljetype. SV: Typ av olja. DA: Olietype. FI: Öljyn tyyppi. ES: Tipo de aceite. PT: Tipo de óleo. EL: Τύπος λαδιού. TR: Yağ tipi. SL: Vrsta olja. HR: Vrsta ulja. SK: Typ oleja. CS: Typ oleje. PL: Typ oleju. HU: Olaj típusa. RO: Tip de ulei. BG: Тип на маслото. RU: Тип масла. ET: Õli tüüp. LV: Eļļas tips. LT: Tepalo tipas. JA: オイルの種類。 ZH: 油型 KO: 오일 유형 TH: ประเภทน้ำมัน MS: Jenis minyak.
20			EN: Specifications and details are subject to change without prior notice. DE: Technische Daten und Details des Geräts können sich ohne vorherige Ankündigung ändern. FR: Ces spécifications et détails sont susceptibles d'être modifiés sans préavis. NL: Specificaties en details kunnen zonder voorafgaande waarschuwing worden gewijzigd. IT: Specifiche e dettagli sono soggetti a modifiche senza preavviso. NO: Spesifikasjonene og detaljene er gjenstand for endringer uten forutgående varsel. SV: Specifikationer och information kan ändras utan föregående meddelande. DA: Ret til ændringer i konstruktion og specifikationer forbeholdes. FI: Rakenteeseen ja teknisiin tietoihin voidaan tehdä muutoksia ilmoittamatta niistä ennalta. ES: Las especificaciones y los datos están sujetos a cambios sin previo aviso. PT: As especificações e os detalhes estão sujeitos a alterações sem aviso prévio. EL: Τα τεχνικά χαρακτηριστικά και οι λεπτομέρειες υπόκεινται σε αλλαγές χωρίς προηγούμενη ειδοποίηση. TR: Özellikler ve ayrıntılar, önceden haber verilmeden değiştirilebilir. SL: Tehnični podatki in podrobnosti se lahko spremenijo brez predhodnega obvestila. HR: Specifikacije i detalji mogu se mijenjati bez prethodne najave. SK: Špecifikácie a podrobnosti sa môžu meniť bez predchádzajúceho upozornenia. CS: Technické údaje a detaily mohou být změněny i bez předchozího upozornění. PL: Specyfikacje i parametry mogą zostać zmienione bez uprzedzenia. HU: A műszaki adatok és részletek előzetes értesítés nélkül megváltozhatnak. RO: Specificațiile și detaliile pot fi modificate fără înștiințare prealabilă. BG: Спецификациите и детайлите подлежат на промяна без предварително уведомление. RU: Технические характеристики и данные могут изменяться без предварительного извещения. ET: Tehnilisi kirjeldusi ja üksikasju võidakse muuta eelneva etteteatamiseta. LV: Specifikācijas un detaļas var tikt mainītas bez iepriekšēja paziņojuma. LT: Konstrukcija ir specifikacijos gali keistis be išankstinio įspėjimo. JA: 仕様および情報は事前通知無しに変更する場合があります。 ZH: 规格和详情如有变更，恕不另行通知。 KO: 사양 및 내용은 예고없이 변경될 수 있습니다. TH: ข้อกำหนดเฉพาะและรายละเอียดสามารถเปลี่ยนแปลงได้โดยไม่ต้องแจ้งให้ทราบล่วงหน้า MS: Spesifikasi dan butiran adalah tertakluk kepada perubahan tanpa notis terlebih dahulu.



HEAD QUARTER

DENMARK

Nilfisk A/S
Kornmarksvej 1
DK-2605 Brøndby
Tel.: (+45) 4323 8100
www.nilfisk.com

SALES COMPANIES

ARGENTINA

Nilfisk Argentina
Herrera 1855 Piso 4° B Ofic 405
Ciudad de Buenos Aires
Tel.: (+54) 11 6091 1576
www.nilfisk.com.ar

AUSTRALIA

Nilfisk Pty Ltd
Unit 1/13 Bessemer Street
Blacktown NSW 2148
Tel.: (+61) 2 98348100
www.nilfisk.com.au

AUSTRIA

Nilfisk GmbH
Metzgerstrasse 68
5101 Bergheim bei Salzburg
Tel.: (+43) 662 456 400 90
www.nilfisk.at

BELGIUM

Nilfisk n.v.-s.a.
Riverside Business Park
Boulevard Internationaalelaan 55
Bâtiment C3/C4 Gebouw
Bruxelles 1070
Tel.: (+32) 24 67 60 50
www.nilfisk.be

BRAZIL

Nilfisk do Brasil
Av. Eng. Luis Carlos Berrini, 550
40 Andar, Sala 03
SP - 04571-000 Sao Paulo
Tel.: (+11) 3959-0300 / 3945-4744
www.nilfisk.com.br

CANADA

Nilfisk Canada Company
240 Superior Boulevard
Mississauga, Ontario L5T 2L2
Tel.: (+1) 800-668-8400
www.nilfisk.ca

CHILE

Nilfisk S.A. (Comercial KCS Ltda)
Salar de Lamara 822
8320000 Santiago
Tel.: (+56) 2684 5000
www.nilfisk.cl

CHINA

Nilfisk
4189 Yindu Road
Xinzhuang Industrial Park
201108 Shanghai
Tel.: (+86) 21 3323 2000
www.nilfisk.cn

CZECH REPUBLIC

Nilfisk s.r.o.
VGP Park Horní Počernice
Do Čertous 1/2658
193 00 Praha 9
Tel.: (+420) 244 090 912
www.nilfisk.cz

DENMARK

Nilfisk Danmark A/S
Industrivej 1
Hadsund, DK-9560
Tel.: 72 18 21 20
www.nilfisk.dk

FINLAND

Nilfisk Oy Ab
Koskelontie 23 E
02920 Espoo
Tel.: (+358) 207 890 600
www.nilfisk.fi

FRANCE

Nilfisk SAS
26 Avenue de la Baltique
Villebon sur Yvette
91978 Courtabouef Cedex
Tel.: (+33) 169 59 87 00
www.nilfisk.fr

GERMANY

Nilfisk GmbH
Guido-Oberdorfer-Straße 2-10
89287 Bellenberg
Tel.: (+49) (0)7306/72-444
www.nilfisk.de

GREECE

Nilfisk A.E.
Αναπαύσεως 29
Κορωπί T.K. 194 00
Tel.: (30) 210 9119 600
www.nilfisk.gr

HOLLAND

Nilfisk B.V.
Versterkerstraat 5
1322 AN Almere
Tel.: (+31) 036 5460760
www.nilfisk.nl

HONG KONG

Nilfisk Ltd.
2001 HK Worsted Mills
Industrial Building
31-39, Wo Tong Tsui St.
Kwai Chung, N.T.
Tel.: (+852) 2427 5951
www.nilfisk.com

HUNGARY

Nilfisk Kft.
II. Rákóczi Ferenc út 10
2310 Szigetszentmiklós-Lakihegy
Tel.: (+36) 24 475 550
www.nilfisk.hu

INDIA

Nilfisk India Limited
Pramukh Plaza, 'B' Wing, 4th floor, Unit
No. 403
Cardinal Gracious Road, Chakala
Andheri (East) Mumbai 400 099
Tel.: (+91) 22 6118 8188
www.nilfisk.in

IRELAND

Nilfisk
1 Stokes Place
St. Stephen's Green
Dublin 2
Tel.: (+35) 3 12 94 38 38
www.nilfisk.ie

ITALY

Nilfisk SpA
Strada Comunale della Braglia, 18
26862 Guardamiglio (LO)
Tel.: (+39) (0) 377 414021
www.nilfisk.it

JAPAN

Nilfisk Inc.
1-6-6 Kita-shinyokohama, Kouhoku-ku
Yokohama, 223-0059
Tel.: (+81) 45548 2571
www.nilfisk.com

MALAYSIA

Nilfisk Sdn Bhd
Sd 33, Jalan KIP 10
Taman Perindustrian KIP
Sri Damansara
52200 Kuala Lumpur
Tel.: (60) 3603 627 43 120
www.nilfisk.com

MEXICO

Nilfisk de Mexico, S. de R.L. de C.V.
Pirineos #515 Int.
60-70 Microparque
Industrial WSantiago
76120 Queretaro
Tel.: (+52) (442) 427 77 00
www.nilfisk.com

NEW ZEALAND

Nilfisk Limited
Suite F, Building E
42 Tawa Drive
0632 Albany Auckland
Tel.: (+64) 9 414 1996
Website: www.nilfisk.com

NORWAY

Nilfisk AS
Bjørnerudveien 24
1266 Oslo
Tel.: (+47) 22 75 17 80
www.nilfisk.no

PERU

Nilfisk S.A.C.
Calle Boulevard 162, Of. 703, Lima 33-
Perú
Lima
Tel.: (511) 435-6840
www.nilfisk.com

POLAND

Nilfisk Sp. Z.O.O.
Millenium Logistic Park
ul. 3 Maja 8, Bud. B4
05-800 Pruszków
Tel.: (+48) 22 738 3750
www.nilfisk.pl

PORTUGAL

Nilfisk Lda.
Sintra Business Park
Zona Industrial Da Abrunheira
Edificio 1, 1° A
P2710-089 Sintra
Tel.: (+351) 21 911 2670
www.nilfisk.pt

RUSSIA

Nilfisk LLC
Vyatskaya str. 27, bld. 7/1st
127015 Moscow
Tel.: (+7) 495 783 9602
www.nilfisk.ru

SINGAPORE

Den-Sin
22 Tuas Avenue 2
639453 Singapore
Tel.: (+65) 6268 1006
www.densin.com

SLOVAKIA

Nilfisk s.r.o.
Bancíkovej 1/A
SK-821 03 Bratislava
Tel.: (+421) 910 222 928
www.nilfisk.sk

SOUTH AFRICA

Nilfisk (Pty) Ltd
Kimbult Office Park
9 Zeiss Road
Laser Park
Honeydew
Johannesburg
Tel: +27118014600
www.nilfisk.co.za

SOUTH KOREA

Nilfisk Korea
#204 2F Seoulsup Kolon Digital Tower
25 Seongsuil-ro 4-gil, Seongdong-gu
Seoul.
Tel.: (+ 82) 2 3474 4141
www.nilfisk.co.kr

SPAIN

Nilfisk S.A.
Torre d'Ara,
Passeig del Rengle, 5 Plta. 10ª
08302 Mataró
Tel.: (34) 93 741 2400
www.nilfisk.es

SWEDEN

Nilfisk AB
Taljegårdsgatan 4
431 53 Mölndal
Tel.: (+46) 31 706 73 00
www.nilfisk.se

SWITZERLAND

Nilfisk AG
Ringstrasse 19
Kircheberg/Industri Stelz
9500 Wil
Tel.: (+41) 71 92 38 444
www.nilfisk.ch

TAIWAN

Nilfisk Ltd
Taiwan Branch (H.K)
No. 5, Wan Fang Road
Taipei
Tel.: (+88) 6227 00 22 68
www.nilfisk.tw

THAILAND

Nilfisk Co. Ltd.
89 Soi Chokechai-Ruammitr
Viphavadee-Rangsit Road
Ladyao, Jatuchak, Bangkok 10900
Tel.: (+66) 2275 5630
www.nilfisk.co.th

TURKEY

Nilfisk A.S.
Serifali Mh. Bayraktar Bulv. Sehit Sk. No:7
Ümraniye, 34775 Istanbul
Tel.: +90 216 466 94 94
www.nilfisk.com.tr

UNITED ARAB EMIRATES

Nilfisk Middle East Branch
SAIF-Zone
P.O. Box 122298
Sharjah
Tel.: (+971) (0) 655-78813
www.nilfisk.com

UNITED KINGDOM

Nilfisk Ltd.
Nilfisk House, Bowerbank Way
Gilwilly Industrial Estate, Penrith
Cumbria CA11 9BQ
Tel.: (+44) (0) 1768 868995
www.nilfisk.co.uk

UNITED STATES

Nilfisk, Inc.
9435 Winnetka Ave N,
Brooklyn Park
MN- 55445
www.nilfisk.com

VIETNAM

Nilfisk Vietnam
No. 51 Doc Ngu Str.
P. Vinh Phuc, Q.Ba Dinh
Hanoi
Tel.: (+84) 761 5642
www.nilfisk.com