



TRALERT®

BETTER LIGHT - WORK SAFER

LED Ronde combinatie achterlichten 12/24v

EU140-serie



EU140STIM



EU140TFM

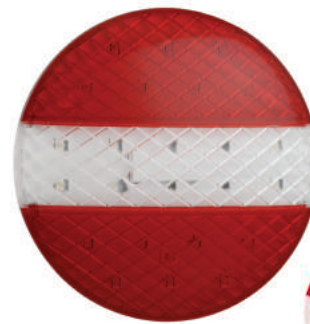

EU140TRM



Eigenschappen

- Universeel ultra plat LED achterlicht
- Mist- en achteruitrijlicht zijn beschikbaar in dezelfde look en ook uitgevoerd met rem- & achterlicht
- Multivoltage 12/24 Volt
- IP67
- Voorzien van E-markering
- EMC ontstoord
- Afm. \varnothing 140 x 20mm
- 5 jaar garantie
- Lamp is zeer eenvoudig te monteren door de handige 3M-plakstrip.

Zeer eenvoudige montage d.m.v de handige 3M-plakstrip aan de achterzijde.

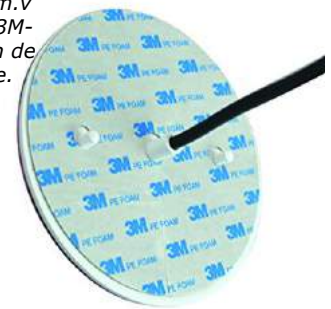

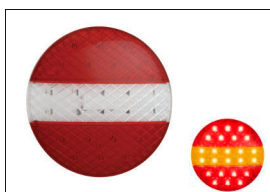
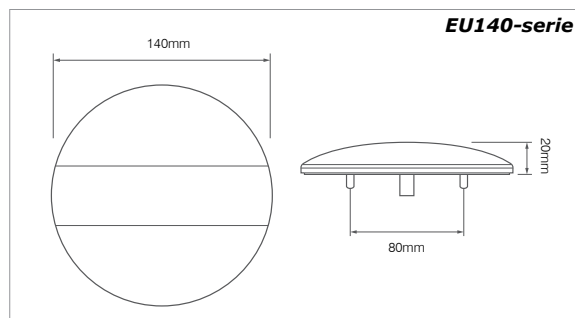

Stroomverbruik (13,8v/28v)

Achterlicht:	0,08A / 0,06A
Remlicht:	0,54A / 0,17A
Knipperlicht:	0,77A / 0,16A
Achteruitrijlicht:	0,39A / 0,06A
Mistlicht:	0,38A / 0,17A

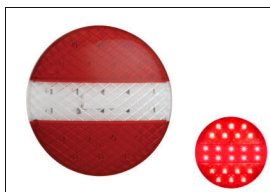

Artikelnummer:	EU140STIM
	- 3 Functie LED achterlicht - 12/24v (multivoltage)
	- 40cm kabel



Artikelnummer:	EU140TFM
	- 3 Functie LED mistlicht - 12/24v (multivoltage)
	- 40cm kabel
	- E-markering rem- & achterlicht alleen geldig i.c.m. de EU140STIM

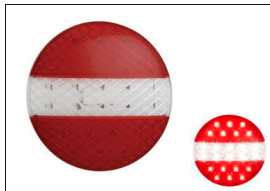

Artikelnummer:	EU140TRM
	- 3 Functie LED achteruitrijlicht - 12/24v (multivoltage)
	- 40cm kabel
	- E-markering rem- & achterlicht alleen geldig i.c.m. de EU140STIM

Achterlicht	Remlicht	Knipperlicht	Mistlicht	Achteruitrijlicht	Kentekerverlichting	Reflector	12 Volt	24 Volt
<input checked="" type="checkbox"/>	<input checked="" type="checkbox"/>	<input checked="" type="checkbox"/>	<input type="checkbox"/>	<input type="checkbox"/>	<input type="checkbox"/>	<input type="checkbox"/>	<input checked="" type="checkbox"/>	<input checked="" type="checkbox"/>

<input checked="" type="checkbox"/>	<input checked="" type="checkbox"/>	<input type="checkbox"/>	<input checked="" type="checkbox"/>	<input type="checkbox"/>	<input type="checkbox"/>	<input type="checkbox"/>	<input checked="" type="checkbox"/>	<input checked="" type="checkbox"/>
-------------------------------------	-------------------------------------	--------------------------	-------------------------------------	--------------------------	--------------------------	--------------------------	-------------------------------------	-------------------------------------

<input checked="" type="checkbox"/>	<input checked="" type="checkbox"/>	<input type="checkbox"/>	<input type="checkbox"/>	<input checked="" type="checkbox"/>	<input type="checkbox"/>	<input type="checkbox"/>	<input checked="" type="checkbox"/>	<input checked="" type="checkbox"/>
-------------------------------------	-------------------------------------	--------------------------	--------------------------	-------------------------------------	--------------------------	--------------------------	-------------------------------------	-------------------------------------