

# Marine Product Catalogue



2019

# Our extensive product range at a glance!



## CRUISE Marine Refrigerators

Elegance						Freeline			
	CRUISE 42	CRUISE 49	CRUISE 65	CRUISE 85	CRUISE 130		ELEGANCE 115		
Classic									
	CRUISE 36	CRUISE 40	CRUISE 42	CRUISE 90	CRUISE 100	CRUISE130 Drink	CRUISE 165, 219, 271		
Inox*					Combi Line				
	CRUISE 36	CRUISE 130 Drink	CRUISE 160 Drink	CRUISE 200		CRUISE 195	CRUISE 220	CRUISE 260	CRUISE 320
Clean Touch									
	CRUISE 42	CRUISE 49	CRUISE 65	CRUISE 85	CRUISE 130				

## CRUISE Marine Freezers

Classic				Inox*			Clean Touch		NEW
	CRUISE 63 F	CRUISE 65 F	CRUISE 90 F		CRUISE 63 F	CRUISE 65 F		CRUISE 90 F	

## DRAWER Marine Refrigerators & Freezers

DRAWER 16 Silver	DRAWER 30 Black	DRAWER 30 Silver	DRAWER 30 White	DRAWER 49** Inox	DRAWER 55** Freezer - Frost-free Inox	DRAWER 65** Inox	DRAWER 65** Frost-free Inox	
						Clean Touch		NEW
DRAWER 85 Inox	DRAWER 105 Inox	DRAWER 130 Inox	DRAWER 160 Light** Inox	DRAWER 160 Combo** Inox	DRAWER 190 Inox		DRAWER 70** Inox	

\* Inox = stainless steel - \*\* Custom Panel version available

### Travel Boxes



### Built-In Boxes



### Cooling Units



### Energy Saving Technology



### Ice Makers



### Divino Wine Cellars & Cooler



### Water Heaters



### Air Heat Exchangers



### On Board Safes





# Table of contents

<b>CRUISE Marine Refrigerators &amp; Freezers</b>	<b>14</b>
Elegance Refrigerators	16
Freeline Elegance Refrigerators	19
Classic Refrigerators	20
Inox Refrigerators	25
Inox Combi Refrigerators	26
Inox Clean Touch Refrigerators	28
Classic Freezers	32
Inox Freezers	32
<hr/>	
<b>DRAWER Marine Refrigerators &amp; Freezers</b>	<b>36</b>
Inox	41
<hr/>	
<b>Cooling Boxes</b>	<b>46</b>
Travel Boxes	48
Built-In Boxes	52
<hr/>	
<b>Cooling Technology</b>	<b>56</b>
Isotherm ITC Digital Display	58
Isotherm Smart Energy Control	59
ASU Technology	60
Frost-free Technology	61
<hr/>	
<b>Cooling Units</b>	<b>62</b>
Compact	64
ASU	65
<hr/>	
<b>Special Design</b>	<b>84</b>
Refrigerators and Freezers	84
<hr/>	
<b>Ice Makers</b>	<b>86</b>
<hr/>	
<b>Wine Cellars &amp; Cooler</b>	<b>90</b>
<hr/>	
<b>Water Heaters</b>	<b>95</b>
<hr/>	
<b>Air Heat Exchangers</b>	<b>100</b>
<hr/>	
<b>On Board Safes</b>	<b>104</b>
<hr/>	



# Welcome to the Indel Webasto Marine Catalogue 2019

---

Indel Webasto Marine, based in Sant'Agata Feltria in Italy, is the successful Joint Venture between the leading automotive supplier Webasto, based in Germany, and the Italian refrigeration leader Indel B. These two companies joined forces to bring high quality galley equipment solutions to marine applications. Indel Webasto Marine stands for high quality products in the marine industry.

***indel B***

**Webasto**

A long history of careful research and development has established the background for successful innovations. Many of these innovations obtained patents and are internationally protected. Our products are exclusively produced using high quality components.

The wide product range consists of refrigerators and freezers, built-in and travel boxes, wine cellars, water boilers, safes as well as customized solutions for more comfort on board. Our refrigeration and freezer solutions are well acknowledged for their user-friendliness, their stylish design and their energy saving engineering.

Our product brand names Isotherm and Isotemp are internationally known and enjoy an excellent reputation on the

market for quality and design. They constitute a major asset for our international distribution network.

Indel Webasto Marine is extending its long tradition of innovation with the introduction of the new CRUISE Elegance Line. This new refrigerator family combines innovative concepts both in style and technology. CRUISE Elegance refrigerators offer not only multiple door customization opportunities but also provide major advantages in fast and effective on board installations. We have also been awarded with the IBEX innovation award for the new unique energy saving technology: the Smart Energy Control is the revolutionary energy control system, capable to increase the efficiency of the Isotherm refrigerators and freezers devices wherever is needed a better on board power management.



*The production lines in Sant'Agata Feltria, Italy.*



*Highly skilled workforce.*



*Exclusive use of high quality compressors.*

# What's new?

---

## **Cruise 90 Freezer Inox Clean Touch: Elegant and Performing**

- Practical Elegance Line handle
- Stainless steel door surface treated with special anti-fingerprint finishing, to easier product cleaning
- Same external dimensions of Cruise 130 for a perfect side-by-side application
- Provided with a 3 side stainless steel flush flange



## **Drawer 30: Performing and space saving**

- Cruise Elegance line family feeling
- Secop BD Micro compressor technology
- Fridge solution
- Easy to use digital display
- Splash proof IPX5 front protection
- Drawer 30 Black: black steel door and steel guides
- Drawer 30 Silver: door finishing in stainless steel (Aisi 304) silver painted and Aisi 304 stainless steel guides
- Drawer 30 White: door finishing in stainless steel (Aisi 304) white painted and Aisi 304 stainless steel guides
- Multiple installation possibilities, via easy-fix or with specific L shape brackets
- 4 side flush frame as optional in three versions: black painted steel (for DR30 Black), Aisi 304 silver painted stainless steel (for DR30 Silver) and Aisi 304 white painted stainless steel (for DR30 White)



## **DRAWER 70 Inox Clean Touch: a complete range fitting your cooling demands**

- Practical Elegance line handle
- Easy to use and maintain thanks to the integrated LED light set and to the stainless steel door anti-fingerprint treated
- Easy to install thanks to the remote compressor option and to the 3 side stainless steel flange
- Robust drawer mechanism with adjustable interior divider
- Available as fridge, freezer or freezer with integrated ice maker



**NEW**



**BI 16: Great usability combined to high development standards**

- Equipped with space saving Secop BD 1.4F Micro compressor solution
- Upper lid with inner recess to store big bottles
- Temperature range from 0°C to +10°C
- Easy to use digital display with splash proof IPX5 front protection



**BI 36: Perfect integration and easy to use**

- Performing technology: high cooling performances
- 12/24 V Secop BD35F compressor
- Easy access to food and drinks from the top
- More installation option solutions
- Space saving solution

**Divino The One: integrated wine cooler**

- Perfect serving temperature for your wine
- Elegant integrated design
- Cool with a dry air jacket: no more wet bottles and water stains
- Performing and reliable: 3 years warranty



**Air-cooled**



- Low power consumption
- Digital interface with accurate display of temperature
- Fridge or freezer (-12°C)
- 12/24 V Secop compressor
- Kit AC / DC optional for a complete power supply compatibility
- Easy installation thanks to "click-on" system

**Water-cooled SP**



- Low power consumption
- Digital interface with accurate display of temperature
- Fridge or freezer (-12°C)
- 12/24 V Secop compressor
- Kit AC / DC optional for a complete power supply compatibility
- Easy installation thanks to "click-on" system
- SP system (patented) to reduce noise of standard fan cooled condenser systems

**Water-cooled Magnum**



- Low power consumption
- Digital interface with accurate display of temperature
- Fridge or freezer (-12°C)
- 12/24 V Secop compressor
- Kit AC / DC optional for a complete power supply compatibility
- Self-priming seawater pump (variable speed) to ensure extra high efficiency for tropical applications



# Isotherm – create your own refrigerator in 6 steps!



## 1. Select the product range

- CRUISE Refrigerator
- DRAWER Refrigerator



## 3. Volume

- Small (< 50 liters)
- Medium (< 89 liters)
- Large (< 135 liters)
- XLarge (> 135 liters)

## 2. Select the desired function(s)

- Fridge
- Fridge/Freezer
- Freezer
- Combo  
(Fridge/Freezer/Ice Maker)



## 4a. Choose the design line

- NEW Elegance Line
- CLASSIC Line
- Inox Line (stainless steel)
- Inox Combi Line
- Inox Clean Touch Line
- Freeline



### Choose the right cooling technology.

If you have a motor boat, equipped with a well-maintained electrical system and you like to go for longer cruises, choose an Isotherm CRUISE refrigerator or a refrigeration system that has a cold-radiating evaporator and traditional thermostat control. If your boat is a sailing yacht and the engine is used for short periods only, we recommend the installation of a fridge or refrigeration system equipped with Isotherm ASU or Smart Energy Control.

#### 4b. Customize your door design

- Colour of panel
- Locking system
- Colour of door frames and handles
- Door opening

#### 5. Power source / Voltage

- DC 12/24 V
- AC/DC 115/220 V 12/24 V\*\*\*
- AC 115 V
- AC 220 V

All options are possible together with the selection of plug type.

#### 4c. Outer frame design

- Frame type
- Frame colour
- Flush integration / no flush integration

#### 6. Refrigeration technology

- Cooling System
  - Air ventilated
  - Water-cooled – SP system (self pumping)
  - Water-cooled – pump (Magnum)
- Special Isotherm technology
  - Isotherm Smart Energy Control
  - ASU\*
  - Frost-free
  - Eutectic plate option\*\*
  - ITC Digital Display

\* ASU option is available on a big part of our models  
 \*\* Plate, which allows accumulation of the cold in order to save energy  
 \*\*\* With additional AC kit



## Configurator for Cooling Units – choose your cooling unit in 4 steps for best customization!

### 1. Function(s)

- Fridge
- Fridge/Freezer
- Freezer

### 2. Volume of box

- Small (< 50 liters)
- Medium (< 89 liters)
- Large (< 135 liters)
- XLarge (> 135 liters)



### 3. Power source / Voltage

- DC 12/24 V
- AC/DC 115/220 V 12/24 V\*\*\*

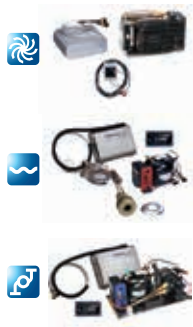

### 4. Refrigeration technology

- Cooling Systems
  - Air ventilated
  - Water-cooled – SP system (Self Pumping)
  - Water-cooled – pump (Magnum)
- Special Isotherm technology
  - Isotherm Smart Energy Control
  - Intelligent Temperature Control
  - ASU\*
  - Frost-free
  - Eutectic plate option\*\*
- Evaporator shapes
  - Flat
  - O-shape
  - L-shape
  - Fin evaporator (VE 150)

\* ASU option is available on a big part of our models  
 \*\* Plate, which allows accumulation of the cold in order to save energy  
 \*\*\* With additional AC kit



## Reliable Marine refrigerators and freezers

Isotherm CRUISE refrigerators and freezers are the result of careful research. Marine refrigerators operate under tough conditions: they must withstand violent movement, operate noiselessly, be thoroughly reliable – and perhaps the most important of all – consume an absolute minimum of battery power.

# CRUISE Marine Refrigerators & Freezers

<b>CRUISE Elegance Refrigerators</b>	<b>14</b>
CRUISE 42 EL	18
CRUISE 49 EL	18
CRUISE 65 EL	19
CRUISE 85 EL	19
CRUISE 130 EL	19
<hr/>	
<b>Freeline Elegance Refrigerators</b>	<b>19</b>
115 EL	19
<hr/>	
<b>CRUISE Classic Refrigerators</b>	<b>20</b>
CRUISE 36	22
CRUISE 40 Cubic	22
CRUISE 42	22
CRUISE 90, 100, 130 Drink	23
CRUISE 165, 219, 271	24
<hr/>	
<b>CRUISE Inox Refrigerators</b>	<b>25</b>
CRUISE 36, 130 Drink, 160 Drink, 200	25
<hr/>	
<b>CRUISE Inox Combi Line</b>	<b>26</b>
CRUISE 195	26
CRUISE 220	26
CRUISE 260	27
CRUISE 320	27
<hr/>	
<b>CRUISE Inox Clean Touch Refrigerators</b>	<b>28</b>
CRUISE 42, 49, 65	30
CRUISE 85	31
CRUISE 130	31
<hr/>	
<b>CRUISE Classic Freezers</b>	<b>32</b>
CRUISE 63 F	34
CRUISE 65 F	34
CRUISE 90 F	34
<hr/>	
<b>CRUISE Inox Freezers</b>	<b>35</b>
CRUISE 63 F	35
CRUISE 65 F	35
<hr/>	
<b>CRUISE Inox Clean Touch Freezer</b>	<b>35</b>
CRUISE 90 F	35

# CRUISE Elegance Marine Refrigerators

It is our mission to design and build high-quality and energy efficient marine refrigeration systems exclusively for sailing yachts and motor cruisers. The CRUISE Elegance Marine refrigerators are available in five sizes starting with 42 up to 130 liters capacity. They convince with their infinite design opportunities as the door panel and the handle can be customized according to the customers expectations. The result: a completely in line interior boat design.

## The ultimate combination of style and technology!



- 5 volumes: 42, 49, 65, 85, 130 liters
- Ready for Isotherm Smart Energy Control
- Innovative vent-lock system
- Easy-fix installation solutions
- Customizable door panel and handle
- Reliability: Secop compressors
- Extra-thick insulation for low power consumption
- White LED internal lighting

By choosing an Isotherm CRUISE Elegance fridge you will enjoy infinite customization options.

- Standard customization options:



White

Black

Teak

Wengè

White oak

Full custom design available on request. (Please contact Indel Webasto Marine)



Example of customization:  
Carbon look

### Product highlights:

- A new handle has been designed to open large sized doors from a central position
- Door panel and handle can be customized in a few minutes
- A wide choice is already available from our stock – special requests can also be processed. (> 300 options)
- Branding/Logo on handle can be implemented on request



### Vent-lock system



With a simple slide of the invisible mechanism, CRUISE Elegance fridges can be switched to ventilation status. The door is kept open while the fridge is out of operation.

### Easy-fix installation solution



The new installation system allows an easy fixing of the cabinet directly from the interior of the fridge. The external flange is no longer necessary for the installation. An innovative internal bushing structure prevents the crushing of the insulated side wall.

### Ready for Isotherm Smart Energy Control

All CRUISE Elegance fridges have been prepared and tested for the installation of Isotherm Smart Energy Control. The location of the sensor is pre-configured in the cabinet



### Cruise Elegance Marine Refrigerators

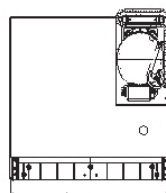
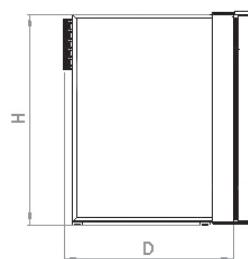
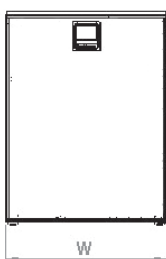

### Product overview: Isotherm CRUISE Elegance Marine Refrigerators

Type	Gross volume (l)	Dimensions H x W x D (mm)	Weight (kg)	Power consumption (W/24 hours)	Secop compressor type	Freezer -6°C/21°F volume in l
CR EL 42	42	525 x 380 x 452* (1)	15	285	BD1.4F	4
CR EL 49	49	525 x 380 x 452*	17,2	265**	BD35F	4
CR EL 65	65	528 x 450 x 470*	19,1	275**	BD35F	4
CR EL 85	85	625 x 475 x 500*	21,9	368**	BD35F	6
CR EL 130	130	750 x 525 x 505*	23,1	418**	BD35F	6
Freeline 115 EL	115	797 x 525 x 495*	29,3	267	BD35F	32

(1) Depth 345 mm with remote compressor

\* Dimensions (to be added) + 50 mm door's depth

\*\* Power consumption can be reduced by up to 50% with the use of an Isotherm Smart Energy Control Kit

Power consumption W/24 h in operation on 12 V with +5°C in the refrigeration space, ambient temperature +25°C according to the Standards ISO 15502:2005 and EN 153:2006

# CRUISE Elegance

CRUISE EL 42, 49, 65



## CRUISE EL 42

The NEW CR 42 EL is the smallest fridge of the CRUISE Elegance line. The fridge features a new inner lining with one adjustable shelf and two retainers inside the door, as well as a freezer compartment with a volume of 4 liters with magnetic steel evaporator door. The compressor, installed on the back of the cabinet, can be removed up to 1 mt. away.

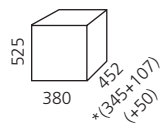

### Isotherm CRUISE EL 42

Type	CR EL 42
Gross volume (l)	42



## CRUISE EL 49

The CR 49 EL features a new inner lining with one adjustable shelf and two retainers inside the door, as well as a freezer compartment with a volume of 4 liters with magnetic steel evaporator door.

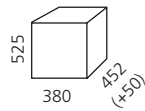

### Isotherm CRUISE EL 49

Type	CR 49
Gross volume (l)	49



## CRUISE EL 65

The CR 65 EL fridge is based on the same inner lining as the CR 49 EL including one adjustable shelf and two retainers inside the door. It also features a freezer compartment with a volume of 4 liters. Magnetic stainless steel evaporator's door.

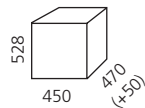

### Isotherm CRUISE EL 65

Type	CR 65
Gross volume (l)	65

### Award Winning Technology (IBEX innovation award 2012)

The new revolutionary energy saving control system:

- Processor-based module
- Minimizes battery consumption
- Ensures compressor always runs at the best COP
- Simple kit, easy to retrofit
- Storage of cooling energy in food and drinks

# CRUISE Elegance

CRUISE EL 85, 130, Freeline 115



## CRUISE EL 85

The CR 85 EL provides the customer a 6 liter freezer compartment, two adjustable shelves and two retainers inside the door. It is ready for Isotherm Smart Energy Control, like all other CRUISE Elegance fridges. Magnetic stainless steel evaporator's door.

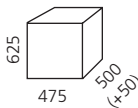

Isotherm CRUISE EL 85	
Type	CR 85
Gross volume (l)	85



## CRUISE EL 130

The CR 130 EL features a separated freezer compartment with a volume of 6 liters, two adjustable shelves and three retainers inside the door. It is equipped with a vegetable bin covered by two glass shelves. Magnetic stainless steel evaporator's door.

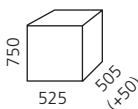

Isotherm CRUISE EL 130	
Type	CR 130
Gross volume (l)	130



## Freeline 115

Freeline 115 liters Elegance provides 83 liters capacity as fridge and 32 liters as freezer. The freezer compartment allows massive food storage thanks to its full width design; it can contain 4 carton boxes of pizza. It is equipped with a modern LED base control panel flush mounted in the cabinet, that permits an easy fridge operation in selecting temperature and reading error codes. ECO function like the overcooling mode, to store cold energy in food and drinks while a surplus of power is available.

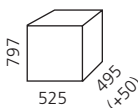

Isotherm Freeline 115	
Type	FL 115
Gross volume (l)	115

# CRUISE Classic, Inox, Combi Line Marine Refrigerators

---

Isotherm CRUISE Refrigerators combine technological innovation with sophisticated, yet practical design. The CRUISE Classic refrigerators are available from 36 liters up to 271 liters and provide numerous customization options.

## Extremely robust yet practical in the use



- Freezer compartment
- High customization possible for door and frame design
- Equipped with interior light and installation frame
- Very low power consumption
- 12/24 V Secop compressor
- Door with a safety lock and magnetic rubber seal
- Compressor unit can be easily removed and, keeping the compressor always in horizontal position, mounted on any vertical wall up to 1.5 m away from the refrigerator (valid for CR 42 only)

### Some configuration options:

- Custom door panel: door panel can be selected according to the customer needs
- Different side frames: 2 up to 3 side frames for an easy installation and 3 up to 4 side frames for a complete flush integration
- Complete stainless steel design (doors and handles)
- Different cooling systems: ventilated as standard, water-cooled with a self pumping kit (patented) and water-cooled through a sea water pump for tropical conditions as option
- Universal AC/DC kit optional: allows sufficient power supply all over the world
- ASU system (patented) or Isotherm Smart Energy Control: options for reduced power consumption

### Some standard features of the CRUISE line include:

- Fan-cooled 12/24 V Secop compressor
- Custom door panels to complement any interior (grey door as standard)
- Freezer compartment (except Drink versions)
- One piece inner lining of food-quality, high density plastic with rounded corners for easy cleaning
- Constructed of corrosion resistant materials
- Interior light (not on CR 36, CR 42, CR 100)
- Magnetic rubber seals keep moisture out and door firmly closed
- Right hand or left hand side opening possible\*

---

\*Due to the door latch position on some CRUISE Stainless Steel Inox line models (CR 90 Freezer, CR 130 Drink, CR 130 and CR 195), right or left swing must be stated when ordering

### Cruise Marine Refrigerators Classic

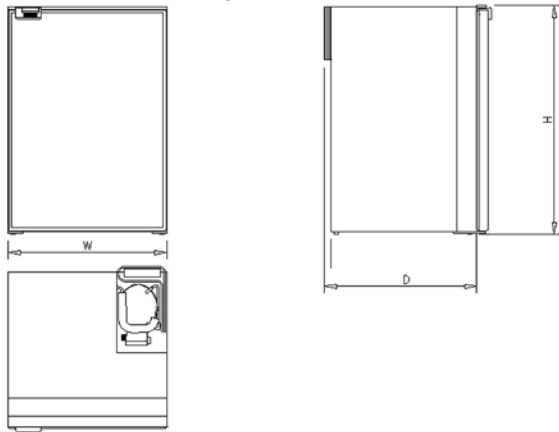

### Cruise Marine Refrigerators Inox

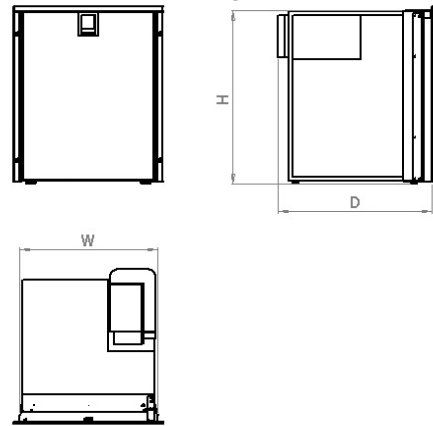

### Product Overview: Isotherm CRUISE Marine Refrigerators

Type	Gross volume (l)	Dimensions H x W x D (mm)	Available with ASU	Available with SEC and ITC	Weight (kg)	Power consumption (W/24 hours)	Secop compressor type	Freezer -6°C/21°F volume in l
CR 36	36	250 x 440 x 715 <sup>1</sup>			16,5	300	BD35F	-
CR 36 Inox	36	255 x 453 x 715			17,5	300	BD35F	-
CR 40 Cubic	40	430 x 420 x 590 <sup>2</sup>			18,5	186	BD35F	40 (-12°C)
CR 42 Classic	42	522 x 380 x 452 <sup>2**</sup>		X	15	300	BD35F	4 (-6°C)
CR 49 Classic	49	523 x 386 x 450 <sup>2</sup>	X	X	16,2	340	BD35F	4 (-6°C)
CR 65 Classic	65	527 x 455 x 480 <sup>2</sup>	X	X	19	360	BD35F	4 (-6°C)
CR 85 Classic	85	620 x 477 x 505 <sup>2</sup>	X	X	22,5	380	BD35F	8 (-6°C)
CR 90	70/20	845 x 478 x 430 <sup>2</sup>			24	520	BD35F	20 (-18°C)
CR 100	100	746 x 487 x 455 <sup>2</sup>	X	X	23,5	400	BD35F	5 (-6°C)
CR 130 Classic	130	746 x 527 x 505 <sup>2</sup>	X	X	23	440	BD35F	8 (-6°C)
CR 130 Drink	130	746 x 527 x 520 <sup>2</sup>			28,5	400	BD35F	-
CR 130 Drink Inox	130	750 x 545 x 560			30	400	BD35F	-
CR 160 Drink Inox	160	870 x 626 x 610			44	512	BD50F	
CR 165	125/40	1210 x 500 x 530 <sup>3</sup>			37	600	BD50F	40 (-18°C)
CR 195 Combi Line*	130/65	1345 x 545 x 580			51	840	2 x BD35F	65 (-18°C)
CR 200 Inox	150/50	868 x 730 x 620			45	800	BD50F	50 (-12°C)
CR 219	178/41	1406 x 550 x 530 <sup>3</sup>			40	650	BD50F	41 (-18°C)
CR 220 Combi Line	220 (130+90)	1545 x 545 x 560			69	400+550	2 x BD35F	
CR 260 Combi Line	260 (130+130)	1545 x 545 x 560			50	400+429	2 x BD35F	
CR 271	218/53	1660 x 550 x 530 <sup>3</sup>			44	700	BD50F	53 (-18°C)
CR 320 Combi Line Fridge/Fridge Fridge/Freezer Freezer/Freezer Fridge/Freezer/Ice Maker	320 (160+160)	1790 x 628 x 610			95	512+530 512+635 512+1100 512+1600	2 x BD50F BD50F + BD80F BD50F + BD80F BD50F + AC Compressor	

(1) Door thickness (to be added): 35 mm - (2) Door thickness (to be added): 40 mm - (3) Door's depth + gasket thickness from cabinet (to be added): 68 mm

\* For CR195 and CR200 Classic are valid the basic drawing specifications as per Inox and Combi Line version - \*\* Depth 345 mm with remote compressor

Power consumption W/24 h in operation on 12 Volt with +5°C in the refrigeration space, ambient temperature +25°C according to the Standards ISO 15502:2005 and EN 153:2006 Refrigerators manufacturing tolerances -2/+4 mm - Dimensions include refrigerator's feet - With AC/DC optional kit, depth may increase

According to EN 603335 - 1 regulation, the inside walls of the furniture housing the refrigerator must be distant from the fridge by 20 mm per side and 50 mm from the top

Please refer to the installation manual for further technical/installation details

Most of Isotherm fridges can also benefit from a retrofitted Isotherm Smart Energy Control kit. On some models it reduces battery consumption by up to 50 %

Specification changes may be made without prior notice

# CRUISE Classic

## CRUISE 36, 40 Cubic, 42



### CRUISE 36

The CR 36 is a built-in drawer fridge with unique design. Due to its compact dimensions, the CR 36 can be installed where no other fridge might fit. The compressor can be removed up to 1.20 meter away, always keeping it in horizontal position. It comes with a white door and mounting frame as standard.

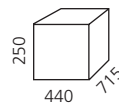

Isotherm CRUISE 36	
Type	CR 36
Gross volume (l)	36



### CRUISE 40 Cubic

The CR 40 Cubic can be used as a fridge or freezer and installed both as a front opening fridge or freezer (Cruise) or as a top opening fridge or freezer (Built-In box). As standard installation the CR 40 Cubic is an ordinary front opening fridge or freezer. By changing position, it can be mounted like a cockpit top opening fridge or freezer as the Isotherm Built-In line products. In this case, keep the compressor as in standard installations (in horizontal position).

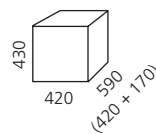

Isotherm CRUISE 40 Cubic	
Type	CR 40 Cubic
Gross volume (l)	40



### CRUISE 42

The CR 42 is a normal-size refrigerator installed in thousands of boats. The compressor unit on the back can be easily removed\* up to 1 mt. away from the refrigerator. The inner cabinet has been totally renewed thanks to the presence of the Elegance line features.

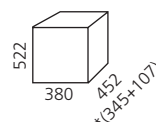

Isotherm CRUISE 42	
Type	CR 42
Gross volume (l)	42

# CRUISE Classic

CRUISE 90, 100, 130 Drink



## CRUISE 90

The CR 90 is a two door fridge-freezer solution. The refrigerator provides a volume of 70 liters and the freezer a volume of 20 liters. The refrigerator is equipped with interior light.

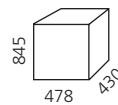

Isotherm CRUISE 90	
Type	CR 90
Gross volume (l)	90



## CRUISE 100

The CR 100 differentiates itself with air ducts and fan ventilated compressor which permits circulation even in tight installations. Additional mounting frames are available as an option. Available with ASU.

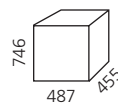

Isotherm CRUISE 100	
Type	CR 100
Gross volume (l)	100



## CRUISE 130 Drink

The CR 130 D is a special version of the CR 130 providing the customer with an extra space for drinks instead of the freezer compartment. It is equipped with interior light and a fan for cool air distribution inside the fridge. Wine bottle racks (as shown on the picture), are available as option.

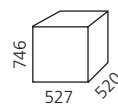

Isotherm CRUISE 130 Drink	
Type	CR 130 D
Gross volume (l)	130

# CRUISE Classic

CRUISE 165, 219, 271



## CRUISE 165

The CR 165 is another two door fridge-freezer solution. The refrigerator provides a volume of 125 liters and the freezer a volume of 40 liters. The refrigerator is equipped with interior light, three shelves and a vegetable bin at the bottom.

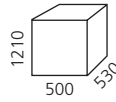

### Isotherm CRUISE 165

Type	CR 165
Gross volume (l)	125 + 40



## CRUISE 219

The CR 219 is a two door fridge-freezer solution. The refrigerator provides a volume of 178 liters and the freezer a volume of 41 liters. The refrigerator is equipped with interior light, four shelves and two vegetable bins at the bottom.

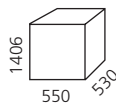

### Isotherm CRUISE 219

Type	CR 219
Gross volume (l)	178 + 41



## CRUISE 271

The CR 271 is a two door fridge-freezer solution. The refrigerator provides a volume of 218 liters and the freezer a volume of 53 liters. The refrigerator is equipped with interior light, four shelves and two vegetable bins at the bottom.

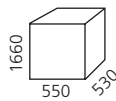

### Isotherm CRUISE 271

Type	CR 271
Gross volume (l)	218 + 53



# CRUISE Inox

CRUISE 36, 130 Drink, 160 Drink, 200

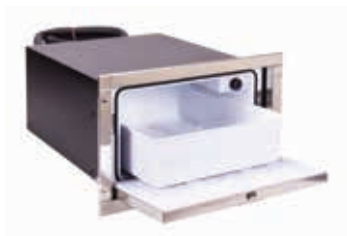

## CRUISE 36 Inox

The CR 36 Inox is a built-in drawer fridge with unique design. Due to its compact dimensions, the CR 36 Inox can be installed where no other fridge might fit. The compressor can be removed up to 1.20 meter away, always keeping it in horizontal position. The Inox model comes with a four side flush mounting frame.

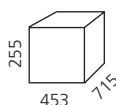

Isotherm CRUISE 36 Inox	
Type	CR 36 Inox
Volume (l)	36



## CRUISE 130 Drink Inox

The CR 130 D Inox is the stainless steel design version of the CR 130 D providing the customer with an extra space for drinks instead of the freezer compartment. It is equipped with interior light and a fan for cool air distribution inside the fridge.

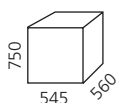

Isotherm CRUISE 130 Drink Inox	
Type	CR 130 D Inox
Gross volume (l)	130



## CRUISE 160 Drink Inox

The CR 160 D Inox is a stainless steel fridge unit, specifically designed to offer spacious on board storage for drinks and beverage, keeping them always at the right temperature thanks to the ventilated evaporator on the back. It is provided with an elegant LED light and it is available with right or left hinged door, nicely integrated thanks to its 3 sides flush flange. Having the same cut-out dimensions of the Drawer 160 Inox light, it is ideal for a side by side application.

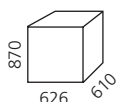

Isotherm CRUISE 160 Drink Inox	
Type	CR 160 D Inox
Gross volume (l)	160



## CRUISE 200 Inox

The CR 200 Inox is a stylish new fridge-freezer in stainless steel design that has been developed to offer spacious on board storage for fresh and frozen foods. It is designed for easy installation under the work surface. The CR 200 Inox is divided into a 150 liters volume fridge section and a 50 liters volume freezer section.

\* Available also with classic doors

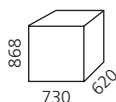

Isotherm CRUISE 200 Inox	
Type	CR 200 Inox
Gross volume (l)	200

# CRUISE Combi Line

## CRUISE 195, 220



### CRUISE 195 Combi Line

The CR 195 Inox is a two door fridge-freezer solution combining a CR 130 refrigerator and a 65 liters freezer. The refrigerator comes with interior light and a vegetable bin. CR195 Inox is equipped with two fan-cooled compressors, separate thermostats for the fridge and freezer sections and is delivered with a flush mounting frame.

\* Available also with classic doors

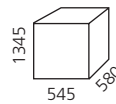

#### Isotherm CRUISE 195 Combi Line

Type	CR 195 COMBI LINE
Gross volume (l)	130 + 65



### CRUISE 220 Combi Line

The CR 220 Inox is a two door fridge-freezer solution in stainless steel, combining a CR 130 fridge on top of a CR 90 liters freezer. Equipped with two fan-cooled compressors with separate thermostats, this combination grants maximum cooling performance. An elegant flush frame is provided, with inner ventilation grilles to easier condenser's cool down process.

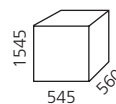

#### Isotherm CRUISE 220 Combi Line

Type	CR 220 COMBI LINE
Gross volume (l)	130+90



# CRUISE Combi Line

## CRUISE 260, 320



### CRUISE 260 Combi Line

The CR 260 Inox is a spacious fridge-fridge solution designed for big vessels. A CR 130 drink refrigerator is positioned on the top, with a practical Drawer 130 liter fridge unit at the bottom. The hybrid combinations of front opening door and the bottom drawer concept gives the CR 260 a stylish and practical impression. The Drawer 130 it is provided with a large drawer mechanism base freezer compartment, and can be delivered with an optional 4th side frame with off-shore lock included.

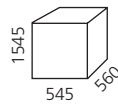

### Isotherm CRUISE 260 Combi Line

Type	CR 260 COMBI LINE
Gross volume (l)	130+130



### CRUISE 320 Combi Line

The CR 320 Inox is an hybrid modular unit, that joins large liter capacity with practical and stylish appearance. A new Cruise 160 Drink is positioned on the top, with a double drawer unit located at the bottom. As per current configuration possibilities, DR 160 Inox can be specified in four versions: both drawers as fridge, both drawers as freezer, one drawer fridge and the other freezer and fridge-freezer with integrated Ice Maker. An elegant flush mounting flange surrounds both units into one easy to install plug & play solution.

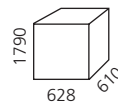

### Isotherm CRUISE 320 Combi Line

Type	CR 320 COMBI LINE
Gross volume (l)	160+160



# CRUISE Inox Clean Touch Marine Refrigerators

The Inox Clean Touch represents the latest development of the world-wide appreciated Elegance product line. It combines in fact the Cruise Elegance line features (except Vent-Lock system) with a new door design in stainless steel especially treated to avoid fingerprints (Inox anti-fingerprint). This new material combines a state of the art marine design with a very easy cleaning and maintenance of the refrigerator. The Elegance line handle is nicely flush mounted into a new door and centrally located to allow easy switch of the hinge opening side.



- 5 volumes; 42, 49, 65, 85, 130 liters
- 3 sides flush mounting frame as standard, 4th side as optional
- High quality stainless steel balcony profiles
- Ready for Isotherm Smart Energy Control & ITC
- Easy fix installation solution
- Reliability: Secop compressors
- Extra-thick insulation for low power consumption
- White LED internal light

## Product Overview: Isotherm CRUISE Inox Clean Touch Marine Refrigerators

Type	Gross volume (l)	Dimensions H x W x D (mm)	Available with SEC and ITC	Weight (kg)	Power consumption (W/24 hours)	Secop compressor type	Freezer -6 °C/21 °F volume in l
CR 42 Inox Clean Touch	42	525 x 400 x 500*	X	11,9	285	BD1.4F	4 (-6°C)
CR 49 Inox Clean Touch	49	525 x 400 x 500	X	17,2	265	BD35F	4 (-6°C)
CR 65 Inox Clean Touch	65	528 x 470 x 520	X	19,1	275	BD35F	4 (-6°C)
CR 85 Inox Clean Touch	85	625 x 495 x 550	X	21,9	368	BD35F	6 (-6°C)
CR 130 Inox Clean Touch	130	750 x 545 x 555	X	23,1	418	BD35F	6 (-6°C)

\* Depth 385 mm with remote compressor

Power consumption W / 24 h in operation on 12 Volt with +5 °C in the refrigeration space, ambient temperature +25 °C according to the Standards ISO 15502:2005 and EN 153:2006  
Refrigerators manufacturing tolerances -2 / +4 mm

Dimensions include refrigerator's feet

With AC / DC optional kit, depth may increase

According to EN 603335 - 1 regulation, the inside walls of the furniture housing the refrigerator must be distant from the fridge by 20 mm per side and 50 mm from the top  
Please refer to the installation manual for further technical / installation details

Most of Isotherm fridges can also benefit from a retrofitted Isotherm Smart Energy Control kit. On some models it reduces battery consumption by up to 50 %

Specification changes may be made without prior notice



# CRUISE Inox Clean Touch

CRUISE 42, 49, 65



## CRUISE 42 Inox Clean Touch

The CR 42 Inox Clean Touch is the stainless steel design version of the CR 42. The Inox Clean Touch version also provides the possibility of removing the compressor unit on the back and mount it on any vertical wall, always keeping the compressor in horizontal position, up to 1 meter away\*.

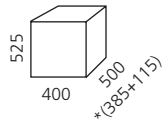

### Isotherm CRUISE 42 Inox Clean Touch

Type	CR 42 CT
Gross volume (l)	42



## CRUISE 49 Inox Clean Touch

The CR 49 Inox Clean Touch is the stainless steel design version of the CR 49. The Inox Clean Touch version also provides the built-in compressor giving better inside dimensions for standing and lying PET bottles. As standard, it is equipped with installation frame and interior LED light.

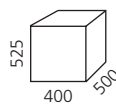

### Isotherm CRUISE 49 Inox Clean Touch

Type	CR 49 CT
Gross volume (l)	49



## CRUISE 65 Inox Clean Touch

The CR 65 Inox Clean Touch is the stainless steel design version of the CR 65. It features a separated freezer compartment and a built-in compressor unit. It is equipped with installation frame and interior LED light as standard.

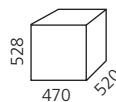

### Isotherm CRUISE 65 Inox Clean Touch

Type	CR 65 CT
Gross volume (l)	65

# CRUISE Inox Clean Touch

CRUISE 85, 130



## CRUISE 85 Inox Clean Touch

The CR 85 Inox Clean Touch is the stainless steel design version of the CR 85. It provides a freezer compartment, two adjustable shelves and a corner-mounted compressor. Interior LED light as standard. Installation flush mounting frames standard (valid for all Inox models).

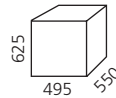

### Isotherm CRUISE 85 Inox Clean Touch

Type	CR 85 CT
Gross volume (l)	85



## CRUISE 130 Inox Clean Touch

The CR 130 Inox Clean Touch is the stainless steel design version of the CR 130 providing a freezer compartment, three shelves, a vegetable bin and a door divided into three sections. It is equipped with interior LED light and a fan cooled compressor as standard.

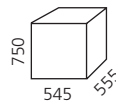

### Isotherm CRUISE 130 Inox Clean Touch

Type	CR 130 CT
Gross volume (l)	130

# CRUISE Classic & Inox Marine Freezers

---

The Isotherm CRUISE freezer units are the perfect complement to CRUISE refrigerators. The high-quality freezers ensure the perfect and constant temperature to keep frozen food on board.



- Extra thick insulation, for excellent cooling performance and low power consumption
- 12/24 V Secop compressor (AC/DC power kit optional)
- Door with safety lock and magnetic rubber seal
- Excellent solution for a side by side fridge-freezer application

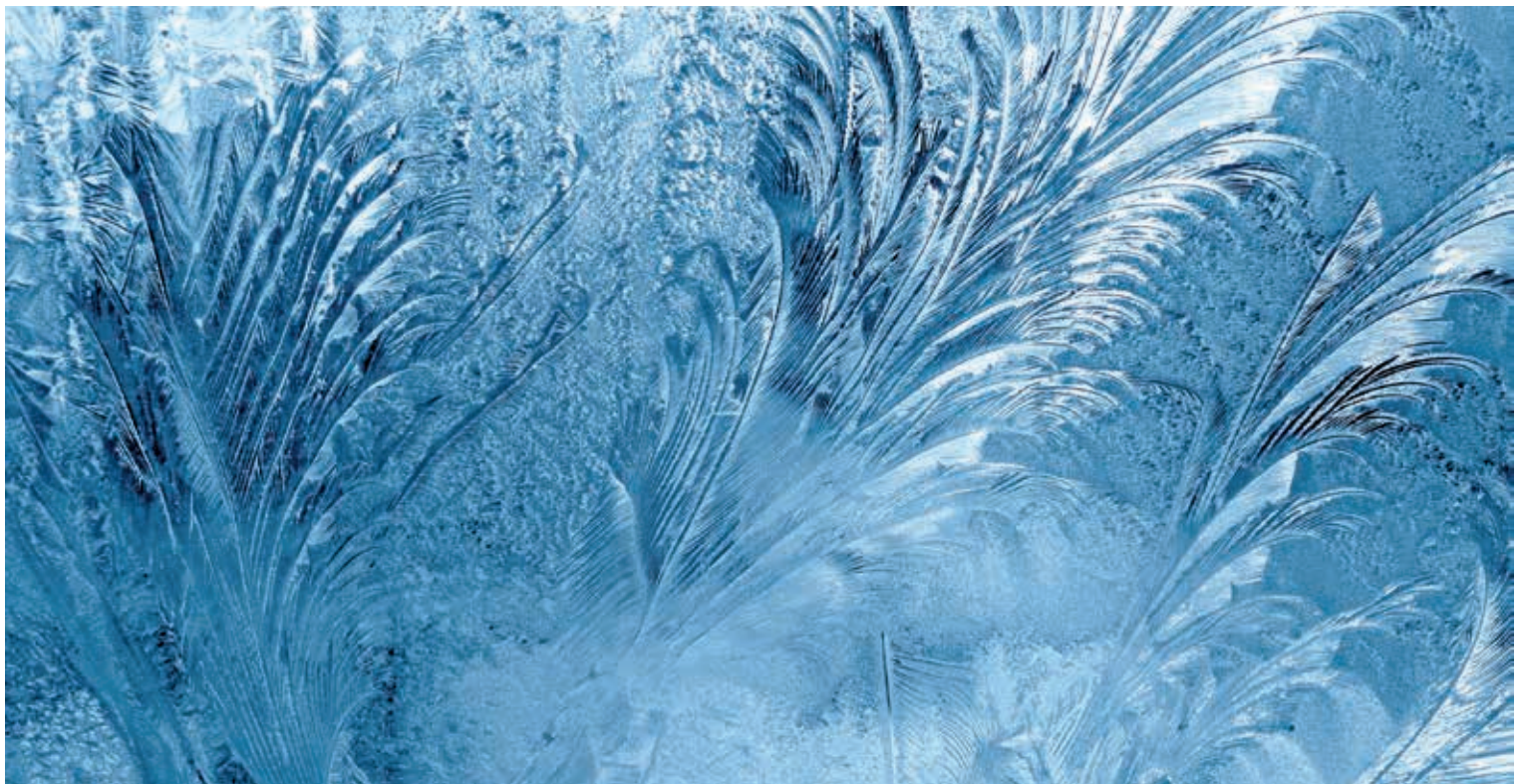



### Cruise Marine Freezers Classic

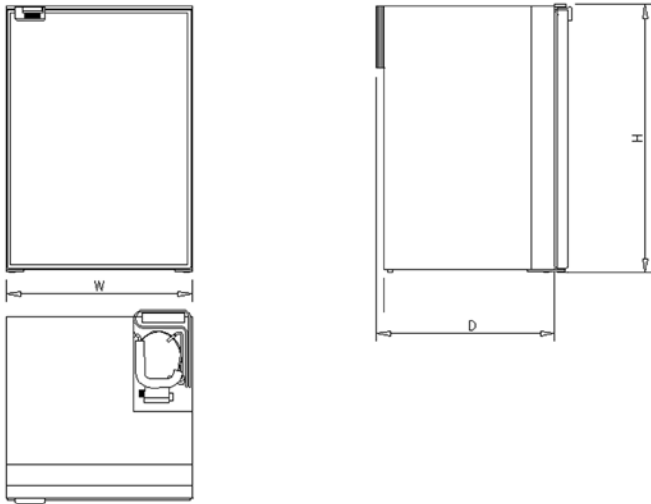

### Cruise Marine Freezers Inox

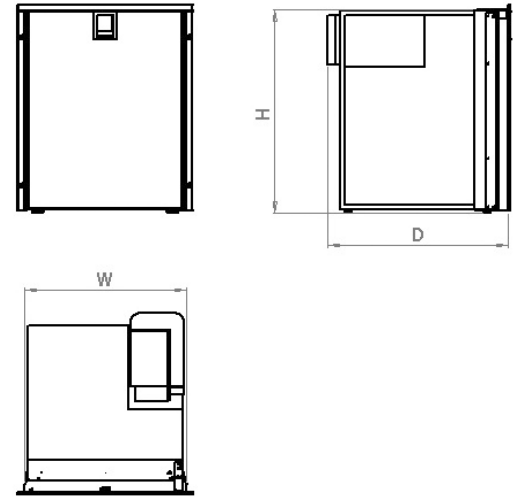

### Product Overview: Isotherm CRUISE Marine Freezers

Type	Gross volume (l)	Dimensions H x W x D (mm)	Weight (kg)	Power consumption (W / 24 hours)	Secop compressor type	Freezer compartment specifications
CR 63 F	63	620 x 477 x 515*	24	440	BD35F	63 (-18°C)
CR 63 F Inox	63	620 x 495 x 555	23	440	BD35F	63 (-18°C)
CR 65 F	65	610 x 527 x 540*	21	440	BD35F	65 (-18°C)
CR 65 F Inox	65	610 x 545 x 580	23	440	BD35F	65 (-18°C)
CR 90 F	90	746 x 527 x 520*	24	550	BD35F	90 (-18°C)
CR 90 F Inox Clean Touch	90	750 x 545 x 555	27,5	650	BD35F	90 (-18°C)

\* Door thickness (to be added): +40 mm

Power consumption W/24 h in operation on 12 Volt with -18°C in the freezer space, ambient temperature +25°C according to the Standards ISO 15502:2005 and EN 153:2006

Refrigerators manufacturing tolerances -2/+4 mm

Dimensions include refrigerator's feet

With AC/DC optional kit, depth may increase

According to EN 603335 - 1 regulation, the inside walls of the furniture housing the refrigerator must distance from the fridge by 20 mm per side and 50 mm from the top

Please refer to the installation manual for further technical/installation details

Specification changes may be made without prior notice

# CRUISE Classic

CRUISE 63 F, 65 F, 90 F



## CRUISE 63 Freezer

The CR 63 Freezer has the same outside dimensions as CR 85 fridge. Therefore these units can be perfectly mounted side by side. CR 63 F is equipped with two shelves and a bin at the bottom. It has a corner-mounted compressor and the evaporator piping is integrated in the walls.

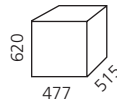

### Isotherm CRUISE 63 Freezer

Type	CR 63 F
Gross volume (l)	63



## CRUISE 65 Freezer

The CR 65 Freezer is a 65 liters volume freezer with extra thick insulation. It is equipped with one shelf and a plastic basket at the bottom. The CR 65 F is delivered with a fan-cooled compressor.

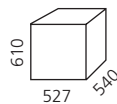

### Isotherm CRUISE 65 Freezer

Type	CR 65 F
Gross volume (l)	65



## CRUISE 90 Freezer

The CR 90 Freezer has the same outside dimensions as the CR130 fridge. Therefore these units can be perfectly mounted side by side. The CR 90 F is equipped with three shelves and four separate lids. It is delivered with a fan-cooled compressor.

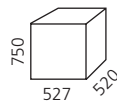

### Isotherm CRUISE 90 Freezer

Type	CR 90 F
Gross volume (l)	90

# CRUISE Inox

## CRUISE 63 F, 65 F, 90 F



### CRUISE 63 Freezer Inox

The CR 63 Freezer Inox has the same outside dimensions as CR 85 Inox fridge. Therefore these units can be perfectly mounted side by side. CR 63 F Inox is equipped with two shelves and a bin at the bottom. It has a corner-mounted compressor and the evaporator piping is integrated in the walls.

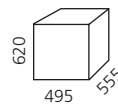

Isotherm CRUISE 63 Freezer Inox	
Type	CR 63 F Inox
Gross volume (l)	63



### CRUISE 65 Freezer Inox

The CR 65 Freezer Inox is a 65 liters volume freezer with extra thick insulation. It is equipped with one shelf and a plastic basket at the bottom. The CR 65 F is delivered with a fan-cooled compressor.

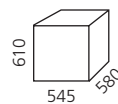

Isotherm CRUISE 65 Freezer Inox	
Type	CR 65 F Inox
Gross volume (l)	65



### CRUISE 90 FREEZER Inox Clean Touch

The CR 90 Freezer Inox Clean Touch with a door in stainless steel especially treated to avoid fingerprints (Inox anti-fingerprint material) has the same outside dimensions, (just 1 cm deeper), as the CR 130 fridge Inox Clean Touch. Therefore these units can be perfectly mounted side by side. The CR 90 Freezer Inox Clean Touch is equipped with three shelves and four separate lids. It is delivered with a fan-cooled compressor as standard.

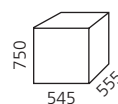

Isotherm CRUISE 90 Freezer Inox Clean Touch	
Type	CR 90 F CT
Gross volume (l)	90



## Easy access to drinks and food: the Isotherm drawer fridges and freezers

The convenient drawer openings allow an easy access to food and drinks.  
An extraordinary stylish design rounds up these highly functional units.

## **DRAWER Marine Refrigerators & Freezers**

DRAWER 16 Silver	41
DRAWER 30 Black - Silver	41
DRAWER 30 White	42
DRAWER 49 Inox	42
DRAWER 55 Inox frost-free	42
DRAWER 65 Inox	43
DRAWER 65 Inox frost-free	43
DRAWER 70 Inox Clean Touch	43
DRAWER 85 Inox	44
DRAWER 105 Inox	44
DRAWER 130 Inox	44
DRAWER 160 Inox Combo	45
DRAWER 160 Inox Light	45
DRAWER 190 Inox	45

# DRAWER Marine Refrigerators & Freezers

---

## Drawer technology for best everyday use!

Isotherm drawer fridges and freezers stand for great design and user-friendliness. High-quality material and robust construction ensure long life time.



- High-tech design
- Easy access, comfortable to use
- Freezer compartment (-6°C)
- Robust drawer mechanism
- Removable drawers for easy cleaning
- Unique frost-free feature on some models

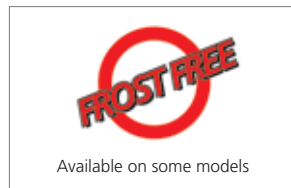

**Special features of the drawer line include:**

- Different side frames: 3 to 4 side frames available, in order to obtain flush mounted installation
- Different cooling systems: ventilated as standard, water-cooled with a self pumping kit (patented) and water-cooled through a sea water pump for tropical conditions
- Universal kit AC/DC optional: allows sufficient power supply all over the world
- Customized frames for side by side applications
- The innovative Isotherm off shore lock prevents the door from being accidentally opened
- Available with the award winning frost-free concept that provides increased energy efficiency: ice accumulation and the resulting higher energy consumption are prevented



**The Drawer 160 Combo, AC only, offers an all in one solution, providing a fridge, a freezer and an ice maker in one system.**



# DRAWER Marine Refrigerators & Freezers

## New Drawer Customization concept:

Indel Webasto Marine provides its customers with even more customization possibilities. On models 49, 55, 65, 70 and 160, it is now possible to customize the door front. The drawer fridge or freezer is supplied with a specifically foamed door ready to be customized, for example, with a real wooden panel supplied by the customer. The panel fixing kit is supplied with the product. Thanks to this new technology it is now possible to select both the finishing of the panel and the handle design, according to the interior of the boat.

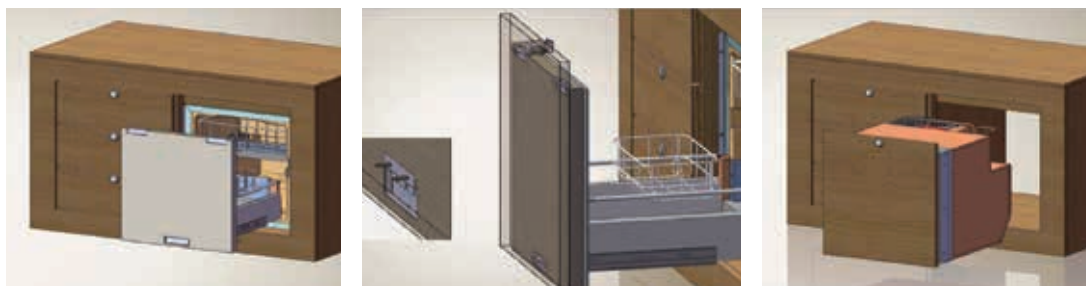

- Perfect integration into the interior design
- Optional door panel mounting brackets
- Side-by-side installation of fridge and freezer
- Customizable safety door locks

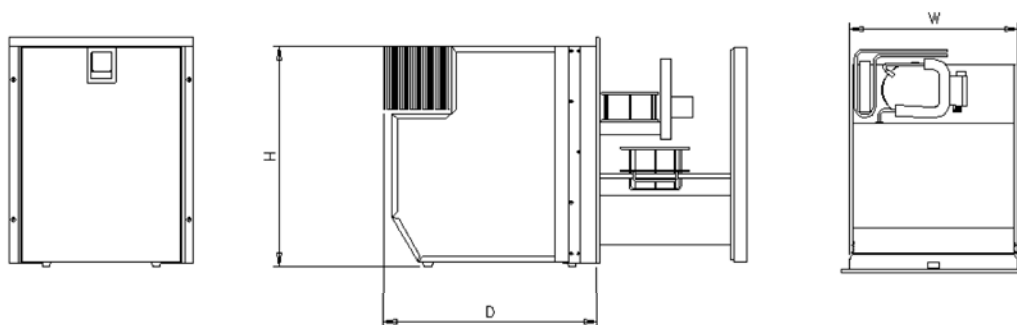

## Product Overview: Isotherm Drawer Marine Refrigerators and Freezers

Type	Gross volume (l)	Dimensions H x W x D (mm) <sup>1</sup>	Weight (kg)	Power consumption* (W / 24 hours)	Secop compressor type
DR 16 Silver	16	250 x 380 x 540	13,9	249	BD 1.4F
DR 30 Black/Silver/White	30	260 <sup>2</sup> x 440 x 700	28,3	270	BD 1.4F
DR 49 Inox	49	520 x 400 x 510	24	400	BD35F
DR 49 Custom Panel	49	520 x 385 x 515	23	400	BD35F
DR 55 frost-free Freezer Inox	55	526 x 470 x 560	26	740	BD35F
DR 55 frost-free Freezer Custom Panel	55	525 x 455 x 570	25	740	BD35F
DR 65 Inox	65	526 x 470 x 545	28	470	BD35F
DR 65 Custom Panel	65	525 x 455 x 550	27	470	BD35F
DR 65 frost-free Inox	65	526 x 470 x 560	28	320	BD35F
DR 65 frost-free Custom Panel	65	525 x 455 x 570	27	320	BD35F
DR 70 Inox Clean Touch Fridge <sup>4</sup>	70	443 x 608 x 737	30	-	BD35F
DR 70 Inox Clean Touch Freezer <sup>4</sup>	70	443 x 608 x 737	-	-	BD50F
DR 70 Inox Clean Touch Freezer - Ice Maker <sup>4</sup>	70	443 x 608 x 737	-	-	AC Compressor
DR 85 Inox	85	625 X 495 X 545	32	370	BD35F
DR 105 Inox	105	515 x 515 x 770 <sup>3</sup>	33	480	BD35F
DR 130 Inox	130	745 X 545 X 545	35	429	BD35F
DR 160 Inox Light Fridge Only <sup>4</sup>	160	865 x 627 x 610	44	530	BD50F
DR 160 Inox Light Freezer Only <sup>4</sup>	160	865 x 627 x 590	46	1100	BD80F
DR 160 Inox Light Fridge Freezer <sup>4</sup>	160	865 x 627 x 610	45	635	BD80F
DR 160 Inox Combo** <sup>4</sup>	160	865 x 627 x 610	46	1600	AC Compressor
DR 190 Inox	190	800 x 900 x 545	44	700	BD50F

\* Power consumption W/24 h in operation at 12 V with + 5°C in the refrigeration space, ambient temperature + 25°C according to the Standards ISO 15502:2005 and EN 153:2006

\*\* Power supply 220 V AC – 50 Hz - 1 With the option of universal AC/DC the depth may increase - 2 D = 250 Without feet - 3 D = 600 without compressor

<sup>4</sup> Custom Panel versions are available on demand (for Drawer 160: fridge only DC, freezer only DC, fridge/freezer DC, Combo AC. Dimensions for all versions 865 x 613 x 610 mm).



# DRAWER Inox

Marine Refrigerators & Freezers

16 Silver, 30 Black, 30 Silver



## DRAWER 16 Silver

The smallest and lightest drawer unit available on the market, unique with its friendly user digital interface. It is provided with stainless steel rails and door in stainless steel, painted in silver colour. The outer feeling is the highly appreciated Elegance design, provided with the typical product line's features as the easy fix installation solution. Equipped with BD 1.4F Secop compressor, it requires minimum installation space. It can be used as a fridge or freezer (-6°C).

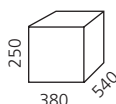

### Isotherm DRAWER 16 Silver

Type	DR 16 Silver
Gross volume (l)	16



## DRAWER 30 Black

The Drawer 30 Black version is a drawer refrigerator with a user-friendly digital interface, specified for internal applications. It is provided with steel rails and black painted steel door. The outer feeling is the highly appreciated Elegance design, provided with the typical product line's features as the easy fix installation solution. Equipped with BD 1.4F Secop compressor, it requires minimum installation space.

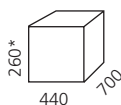

### Isotherm DRAWER 30 Black

Type	DR 30 Black
Gross volume (l)	30

\* 250 without feet



## DRAWER 30 Silver

The Drawer 30 Silver premium version is a drawer refrigerator with a user-friendly digital interface. It is provided with AISI 304 stainless steel rails and stainless steel door, painted in silver colour. The outer feeling is the highly appreciated Elegance design, provided with the typical product line's features as the easy fix installation solution. Equipped with BD 1.4F Secop compressor, it requires minimum installation space.

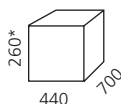

### Isotherm DRAWER 30 Silver

Type	DR 30 Silver
Gross volume (l)	30

\* 250 without feet

# DRAWER Inox

## Marine Refrigerators & Freezers

30 White, 49, 55 frost-free



\* 250 without feet

### DRAWER 30 White

The Drawer 30 White version is a drawer refrigerator with a user-friendly digital interface. It is provided with AISI 304 stainless steel rails and stainless steel door, painted in white colour. The outer feeling is the highly appreciated Elegance design, provided with the typical product line's features as the easy fix installation solution. Equipped with BD 1.4F Secop compressor, it requires minimum installation space.

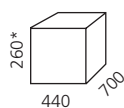

#### Isotherm DRAWER 30 White

Type	DR 30 White
Gross volume (l)	30



### DRAWER 49 Inox

The DR 49 Inox is a new, space-saving, drawer unit with stainless steel front door. The interior is designed to suit international cans and food packs with two robust drawers, conventional international sizes of integrated adjustable bars, freezer compartment (-6°C) and internal blue LED light.

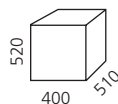

#### Isotherm DRAWER 49 Inox

Type	DR 49 Inox
Gross volume (l)	49



### DRAWER 55 frost-free Freezer Inox

The DR 55 freezer is a 55 liters capacity stainless steel front opened drawer freezer. This model combines innovative stainless steel design with the most modern technology such as automatic defrost which allows having home comfort on board. The DR 55 F is equipped with an internal fan for temperature constant control and a sequence of 5 LED lights for blue internal light.

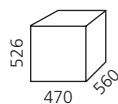

#### Isotherm DRAWER 55 frost-free Freezer Inox

Type	DR 55 F Inox
Gross volume (l)	55

# DRAWER Inox

Marine Refrigerators & Freezers

65, 65 frost-free, 70 Clean Touch



## DRAWER 65 Inox

The DR 65 Inox is a space-saving, front-opened drawer. Its new design is based on the standard 65 liter refrigerator but with a pull-out drawer featuring an innovative interior concept with bins, bottle racks and a freezer compartment (-6°C). A sequence of 5 LED lights provides blue internal light.

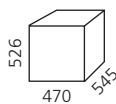

Isotherm DRAWER 65 Inox	
Type	DR 65 Inox
Gross volume (l)	65



## DRAWER 65 frost-free Inox

The DR 65 Inox is a space-saving, front-opened drawer, providing a volume of 65 liters with bins and bottle racks. It combines the most modern technology with automatic defrost allowing home comfort on board. For constant temperature control, an internal fan is mounted. A sequence of 5 LED lights provides blue internal light. Ideal for a side by side installation with the DR 55 Inox freezer.

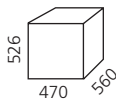

Isotherm DRAWER 65 frost-free Inox	
Type	DR 65 Inox
Gross volume (l)	65



## DRAWER 70 Inox Clean Touch

The DR70 Inox Clean Touch is the premium front-opened drawer solution with a door in stainless steel especially treated to avoid fingerprints. This new material combines a state of the art marine design with easy cleaning and maintenance of the refrigerator. It is provided with a robust drawer mechanism, 5 led lights and an adjustable interior divider, to provide great comfort in use. The 3 sides stainless steel flange allows an easy recess in furniture, as well as the remote compressor option facilitate the compressor location up to 1.1mt away from the cabinet. It is available in three different versions, as fridge (DC), freezer (DC) and freezer with Ice Maker integrated (AC).

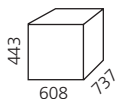

Isotherm DRAWER 70 Inox Clean Touch	
Type	DR 70 Inox Clean Touch
Gross volume (l)	70

# DRAWER Inox

## Marine Refrigerators & Freezers

85, 105, 130



### DRAWER 85 Inox

The DR 85 Inox is a drawer refrigerator in stainless steel design providing a gross internal volume of 85L. The main drawer-door mechanism is the top quality Isotherm solution, capable to ensure safe and large storage for food and drinks. A bottle rack is provided on the main counter door. Two inner drawers are available to ensure the maximum usability as well as great storage, with the top one as freezer compartment (-6°C).

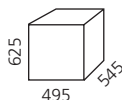

#### Isotherm DRAWER 85 Inox

Type	DR 85 Inox
Gross volume (l)	85



### DRAWER 105 Inox

The DR 105 Inox drawer fridge gives opportunities for installations where a normal refrigerator would not fit. It can be installed as the main galley fridge, as a cockpit bar or even on the fly-bridge. The front panel is available in stainless steel or as a raw foamed drawer front, providing the possibility of mounting individual wooden front panels to fit the boat's interior.

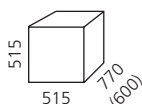

#### Isotherm DRAWER 105 Inox

Type	DR 105 Inox
Gross volume (l)	105



### DRAWER 130 Inox

The DR 130 Inox is a drawer refrigerator in stainless steel design providing a gross internal volume of 130L. The main drawer-door mechanism is the top quality Isotherm solution, capable to ensure safe and large storage for food and drinks. A bottle rack and a patented modular shelves disposal are provided on the main counter door. Two inner drawers are available to ensure the maximum usability as well as great storage, with the top one as freezer compartment (-6°C).

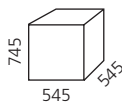

#### Isotherm DRAWER 130 Inox

Type	DR 130 Inox
Gross volume (l)	130

# DRAWER Inox

## Marine Refrigerators & Freezers

160 Combo , 160 Light, 190



### DRAWER 160 Inox Combo

The DR 160 Inox Combo is a double-drawer set up, which offers both a fridge and a freezer solution and the additional convenience of an ice maker. The upper drawer of this model consists of a refrigeration compartment with a 90 liter volume while the lower one combines a 65 liter freezer and ice maker with a 6 liter ice case. The total internal volume adds up to 155 liters while the outer dimensions remain very compact. The DR 160 can be supplied with 230 V 50 Hz. Mechanical thermostat and internal light on the upper drawer.

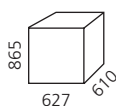

#### Isotherm DRAWER 160 Inox Combo

Type	DR 160 Inox Combo
Gross volume (l)	160



### DRAWER 160 Inox Light

The DR 160 Inox Light is an evolution of the successful DR160 Inox Combo. This unit works on 12/24 V and is available in three versions: both drawers as fridges, both drawers as freezers or one drawer as a fridge and one drawer as a freezer. Mechanical thermostat and internal light (no internal light on double freezer version). AC/DC kit optional.

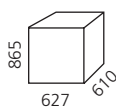

#### Isotherm DRAWER 160 Inox Light

Type	DR 160 Inox Light
Gross volume (l)	160



### DRAWER 190 Inox

The DR 190 Inox is a drawer refrigerator in stainless steel design with two separate drawers providing practical adjustable interior equipment. It is equipped with a fan-cooled compressor mounted on the rear side and delivered with a three side mounting frame for flush mounting.

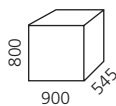

#### Isotherm DRAWER 190 Inox

Type	DR 190 Inox
Gross volume (l)	190



## For daily use and in extreme conditions

No matter where you decide to cruise, Cooling Boxes offer the right cooling solution for your boat or yacht. Travel Boxes are extremely performing and especially convenient for daily use thanks to their light and compact design.

# Cooling Boxes

<b>Travel Boxes</b>	<b>48</b>
TB 13	50
TB 18	50
TB 31	50
TB 41	50
TB 51	51
<hr/>	
<b>Built-In Boxes</b>	<b>52</b>
BI 16	53
BI 29 Dual	53
BI 36	53
BI 40	54
BI 41 Dual	54
BI 53 F	54
BI 75	55
BI 92 Dual	55
BI 172 Dual	55

---



# Cooling Boxes

## Travel Boxes

**Your reliable partner for daily use and / or in extreme conditions!**

No matter where you decide to cruise, Isotherm Travel Boxes offer the right cooling solution for your boat or yacht. The travel box TB 13 and TB 18, thanks to the new BD 1.4F compressor, are very compact like thermoelectric fridges but extremely performing. TB 31, 41 and 51 are especially convenient for daily use thanks to their light and compact design.



TB 31, TB 41, TB 51



TB 13



TB 18

- Very light and compact design for outdoor conditions
- Large capacities to store food and drinks (13 – 49 litres)
- Large units equipped with handles for an easy transport
- Reliability: Secop compressor and universal AC/DC electronic unit
- Easy to carry, adjustable shoulder strap available for TB 18
- 3 years full warranty and 5 years limited warranty on compressor's mechanical parts (labour excluded)





Optional fixing plate available for TB13

#### Compact and performing: TB 13

- Operating temperature range from +10°C to -18°C
- Easy to use thermostat knob
- DC 12/24V power cable for cigarette lighter plug
- Very light and compact design
- Micro compressor technology



#### Inimitable travel mate: TB 18

- Very light and compact design, easy to carry 8.6 kg
- Equipped with NEW BD 1.4F compressor, the smallest and lightest DC unit on the market
- Internal LED light
- Electronic thermostat with easy to use display
- Adjustable shoulder strap



#### Robust, reliable but also convenient: TB 31, 41 and 51

- Pull out inner basket for easy access (not on TB 31)
- Strong soft touch carrying handles
- Very light and compact dimensions
- Internal LED light
- Electronic thermostat control to maximize energy savings
- New sturdy injection molded lid with integrated closing system



#### Product Overview: Travel Boxes

Type	Gross Volume (l)	Dimensions H x W x D (mm)	Weight (kg)	Power consumption* (W / 24 hours)	Secop compressor type	Energy Efficiency Class
TB 13 12/24 V DC	13	360 x 225 x 535	8,5	150	BD1.4F	
TB 18 12/24 V DC	18	405 x 235 x 565	9	150	BD1.4F	
TB 31 AC/DC	29	380 x 585 (+115) x 350	16	220	BD35F	A+
TB 41 AC/DC	39	445 x 585 (+115) x 350	18	225	BD35F	A+
TB 51 AC/DC	49	530 x 585 (+115) x 350	20	230	BD35F	A+

\* Power consumption W/24 h in operation at 12 V with + 5°C in the refrigeration space, ambient temperature + 25°C according to the Standards ISO 15502:2005 and EN 153:2006.

# Cooling Boxes

## Travel Boxes

13, 18, 31, 41



**TB 13 DC**

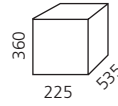

### Isotherm Travel Box 13

Type	TB 13 DC
Gross Volume (l)	13
Weight (kg)	10.1
Internal dimensions	290 x 145 x 295



**TB 18 12/24 V DC**

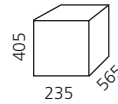

### Isotherm Travel Box 18

Type	TB 18 12/24 V DC
Gross Volume (l)	18
Weight (kg)	8.6
Internal dimensions	260 x 170 x 290



**TB 31 AC/DC**

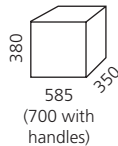

### Isotherm Travel Box 31

Type	TB 31 AC/DC
Gross Volume (l)	29
Weight (kg)	18
Internal dimensions	290 x 270 x 315



**TB 41 AC/DC**

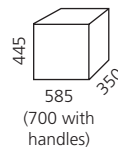

### Isotherm Travel Box 41

Type	TB 41 AC/DC
Gross Volume (l)	39
Weight (kg)	21
Internal dimensions	355 x 270 x 314

# Cooling Boxes

## Travel Boxes

51



TB 51 AC/DC

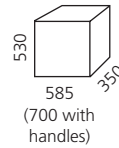

Isotherm Travel Box 51	
Type	TB 51 AC/DC
Gross Volume (l)	49
Weight (kg)	23
Internal dimensions	440 x 270 x 315



# Cooling Boxes

## Built-In Boxes

Great flexibility of installation, optimum use of on-board space.



- 12/24 V Secop compressor
- Plastic or stainless steel inside lining to avoid any damage even after contact with salt water
- Roller slides available for BI 29 as an option
- Evaporator integrated in the foam allows easy cleaning(except BI 40)
- Top can be customized

Built-in cooling boxes allow an optimized use of space on board thanks to the top-loading access to the interior. They are extremely flexible in size and design.

### The advantages of a built-in cooling box:

- Easy access to food and drinks from the top
- Better installation options
- Extremely space saving
- Customizing options for the lid allow for perfectly adapte design

The CRUISE 40 Cubic can also be installed as a built-in top opening cooler box.

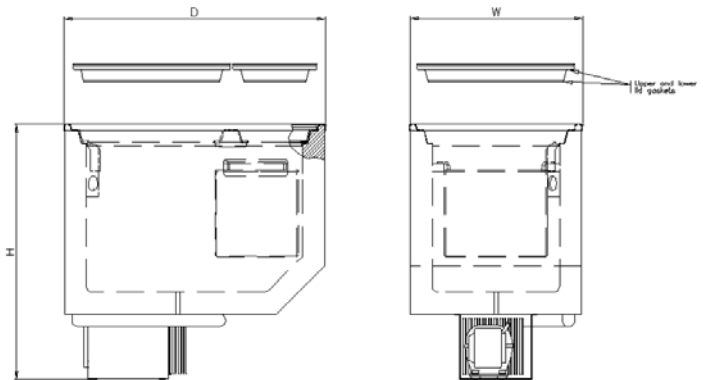

### Product Overview: Built-In Cooling Boxes

Type	Gross volume (l)	Dimensions H x W x D (mm)	Available with ASU	Water cooled option	Weight (kg)	Power consumption* (W/24 hours)	Secop compressor type
BI 16	16	557 x 384 x 240			11,9	-	BD1.4F
BI 29***	29	370 x 342 x 505 + 165		X	19	250	BD35F
BI 36	36	710 x 438 x 240			15,3	-	BD35F
BI 40	40	380 x 395 x 395 + 165	X	X	15,5	270	BD35F
BI 41***	41	450 + 165 x 496 x 340		X	19	270	BD35F
BI 53 F**	53	465 + 165 x 645 x 425		X	26	260	BD50F
BI 75**	75	465 + 165 x 645 x 425		X	26	340	BD35F
BI 92***	92	455 + 165 x 801 x 480		X	28	360	BD50F
BI 172	Fridge 172	840 x 1015 x 560		X	45	357	BD50F
BI 172	130 + 38	840 x 1015 x 560		X	45	603	BD50F

\* Power consumption in operation on 12 Volt with +5°C in the refrigeration space, ambient temperature +25°C according to the Standards ISO 15502:2005 and EN 153:2006

\*\* External flange in stainless steel optional available - \*\*\* The built-in box operates as a fridge or freezer - Specification changes may be made without prior notice.

# Cooling Boxes

## Built-In Boxes

BI 16, BI 29 Dual, BI 36



### BI 16

The BI 16 is a refrigerator box equipped with the space saving Secop BD Micro compressor solution. The upper lid with inner recess allows big bottles storage. Temperature range 0°C to +10°C. It combines great usability to high development standards, thanks to its easy to use digital display and to a splash proof IPX5 front protection.

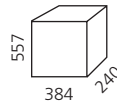

#### Isotherm Built-In 16

Type	BI 16
Gross volume (l)	16



### BI 29 Dual

The BI 29 is a refrigerator or freezer box with stainless steel inner lining and plastic bottom section. It offers a range of +10°C to -12°C. Equipped with roller slides (optional) the box can be used as a drawer.

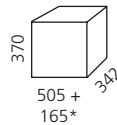

#### Isotherm Built-In 29

Type	BI 29
Gross volume (l)	29



**NEW**

### BI 36

The BI 36 is a top loading refrigerator box equipped with Secop BD35F 12/24V DC compressor. The product is meant to be integrated into customer's furniture and customized in finishing via the upper lid, granting safe hinging according to product application type and layout specifications. Temperature range from 0°C to +10°C. It combines great usability to high development standards.

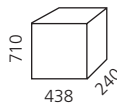

#### Isotherm Built-In 36

Type	BI 36
Gross volume (l)	36

# Cooling Boxes

## Built-In Boxes

### BI 40, 41 Dual, BI 53 F



#### BI 40

The BI 40 is a built-in refrigerator box. It is equipped with an L-shaped evaporator. The fan-cooled compressor is mounted on the side. The BI 40 is also available with ASU. Other compressor options as SP or Magnum are also available.

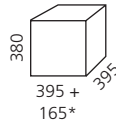

Isotherm Built-In 40	
Type	BI 40
Gross volume (l)	40



#### BI 41 Dual

Il BI 41 è un frigo o freezer con finiture interne in acciaio inossidabile, sezione inferiore in plastica e cestello. Ha temperatura operativa da +10°C a -10°C. Il compressore ventilato è montato sul fondo, ma può essere facilmente posizionato fino a 1,5 metri di distanza. Sono disponibili anche compressori opzionali diversi, come SP e Magnum.

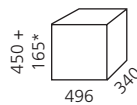

Isotherm Built-In 41	
Type	BI 41
Gross volume (l)	41



#### BI 53 F

The BI 53 F is a built-in freezer box with stainless steel inner lining, plastic bottom section and a wire basket. It offers a range of 0°C to -20°C and is equipped with interior light. Its fan-cooled compressor unit is mounted below but easily repositioned up to 1.5 meters away. Other compressor options as SP or Magnum are also available.

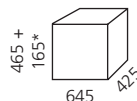

Isotherm Built-In 53 F	
Type	BI 53
Gross volume (l)	53

\*Compressor dimensions; if removed, always keep it in horizontal position.

# Cooling Boxes

## Built-In Boxes

### BI 75, BI 92 Dual, BI 172 Dual



#### BI 75

The BI 75 is a built-in fridge box with stainless steel inner lining, plastic bottom section and one wire basket. It is equipped with interior light. Its fan-cooled compressor unit is mounted below but easily repositioned up to 1.5 meter away. Other compressor options as SP or Magnum are also available.

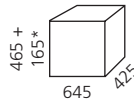

Isotherm Built-In 75	
Type	BI 75
Gross volume (l)	75



#### BI 92 Dual

The BI 92 is a built-in fridge or freezer box with stainless steel inner lining, plastic bottom section and three wire baskets. It offers a range of +10°C to -20°C and is equipped with interior light. Its fan-cooled compressor unit is mounted below but easily repositioned up to 1.5 meter away. Other compressor options as SP or Magnum are also available.

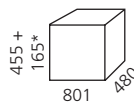

Isotherm Built-In 92	
Type	BI 92
Gross volume (l)	92

\*Compressor dimensions; if removed, always keep it in horizontal position



#### BI 172 Dual

Built-In 172 DUAL is a combined cooling solution 130 liter fridge & 38 liter freezer or 172 liter fridge only, capable to work on a multiple use base. Top loading openings for fridge and freezer compartments and front loading opening for fridge compartment are possible. The innovative concept at the base of the BI172 is modularity both in use and application. It is the end user deciding the product functions, according to his needs. DC or AC/DC versions available.

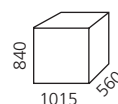

Isotherm Built-In 172	
Type	BI 172
Gross volume (l)	172



## **Isotherm Exclusive Cooling Technology**

Energy is a precious resource on board of any boat or yacht. Indel Webasto Marine continuously improves its energy management solutions to provide better efficiency and clever power savings to customers.



# Cooling Technology

<b>Isotherm Intelligent Temperature Control</b>	<b>58</b>
<b>Isotherm Smart Energy Control</b>	<b>59</b>
<b>ASU Technology</b>	<b>60</b>
<b>Frost-free Technology</b>	<b>61</b>

# Cooling Technology

## Isotherm Intelligent Temperature Control & Smart Energy Control

### NEW - Isotherm ITC Digital display



The ITC Digital Display clearly shows, controls and regulates temperature in a refrigerated compartment from the exterior

of a fridge/freezer cabinet. It is dedicated to people who desire a nice-looking interface and a refined product interaction, as well as reduce on board power consumption. Thanks to the presence of an air sensor in the cabinet, the electronic control unit detects the actual air temperature and processes that in combination with the user selected settings, in order to define the

compressor operation. Remote product interaction is extremely easy and accurate since data readings appear on the display, like temperature set or detected, selection of energy saving operations, compressor's operation mode settings, (ITC, Eco and Overcooling mode) and choice of 3 battery protection levels. Product integration is simple, since the device is compatible with control units Indel Webasto Marine P/N SEG00002DA and SEG00030GA (respectively Secop versions 101N0212 and 101N0510 for BD35/50F) allowing a recess flush installation and a wall mounted.



#### Convincing factors are:

- Available as retrofit kit or originally fitted on fridges in the factory
- Up to 25% energy saving due to a more efficient use of the compressor
- Up to 40% savings with combined effects of stored cooling energy in food and drinks
- Quick cooling in boost mode
- Soft start to avoid starting peaks
- Eco mode
- Easy to set battery protection directly from the display

## Isotherm Smart Energy Control



### Isotherm Smart Energy Control is a simple kit.

This kit can be easily retrofit to upgrade the energy saving

capabilities of most Isotherm refrigeration products.

The new CRUISE Elegance line provides a preformed location in the cabinet for the temperature sensor.

### How does it work?

The sophisticated, processor-based Isotherm Smart Energy Control technology achieves significant power consumption savings by continuously scanning a set of key environmental factors to determine, through advanced proprietary algorithms, what is the most relevant compressor speed to maximize the performance/battery drain ratio (COP).



A dedicated air sensor which can continuously measure the cabinet air temperature.



Potentiometer to activate the Isotherm Smart Energy Control mode.



Processor-based module to be connected to the Secop compressor.

The device not only makes your fridge intelligent but also allows the storage of a significant amount of cold energy into the loaded food and drinks. Isotherm Smart Energy Control reduces the cabinet temperature more than a traditional fridge without freezing the food. This is continuously monitored by an air sensor in the cabinet. The cooling energy is stored when a power surplus is available (engine on or connection to grid) and reused first, before the fridge is running on battery.

### The result: Significant energy savings.

#### External factors

- Cabinet air temperature
- Temperature set point
- Battery charge status
- Battery voltage

#### Configuration Parameters

- Cabinet size
- Offset values

#### Available potential of DC fridges

- Energy storage potential of loaded food/drinks
- Variable speed capability of DC compressors



#### Energy Savings

- Maximized performance/battery drain ratio (COP)
- Reuse of energy stored in food/drinks
- Speed modulation: Soft start up and boost mode

#### Multiple benefits from a simple kit:

- Up to 35 % savings due to a more efficient use of the compressor
- Up to 50 % savings with combined effects of stored cooling energy in food and drinks
- No need for eutectic plates/special storage devices
- Easy to retrofit
- Quick cooling in boost mode
- Soft start to avoid starting peaks



#### Can your fridge be upgraded?

Most Isotherm refrigeration products can be upgraded with Isotherm Smart Energy Control. Please contact your dealer to request application and installation guidelines.

# Cooling Technology

## ASU technology

### Isotherm ASU charges the holding plate while the engine is running.

The patented ASU system has now been available for several years and has been installed on tens of thousands of boats worldwide. The ASU system starts the compressor when the engine is running and the power is available to freeze the holding plate completely. The energy stored in the holding plate will keep the refrigerator cool for many hours. When the engine is stopped, the compressor will not restart until the cold stored in the plate is totally consumed. Once the stored cold is completely consumed, the compressor starts to run for short periods to maintain the required temperature in the box.

With its unique principle of operation – the patented ASU “Automatic Start Up” system – Isotherm ASU has an important competitive advantage over traditional refrigerators.

#### ASU – Automatic Start Up

This unique system is designed to start the compressor with up to 75% of its performance mainly when the engine is running and plenty of power is available. Using a powerful compressor (a three-phase compressor with full-range speed control) is highly recommended as it achieves a quicker freezing of the holding plate. By taking advantage of the surplus energy generated by the alternator when the engine is running, the ASU feature does not reduce the engine’s effectiveness.

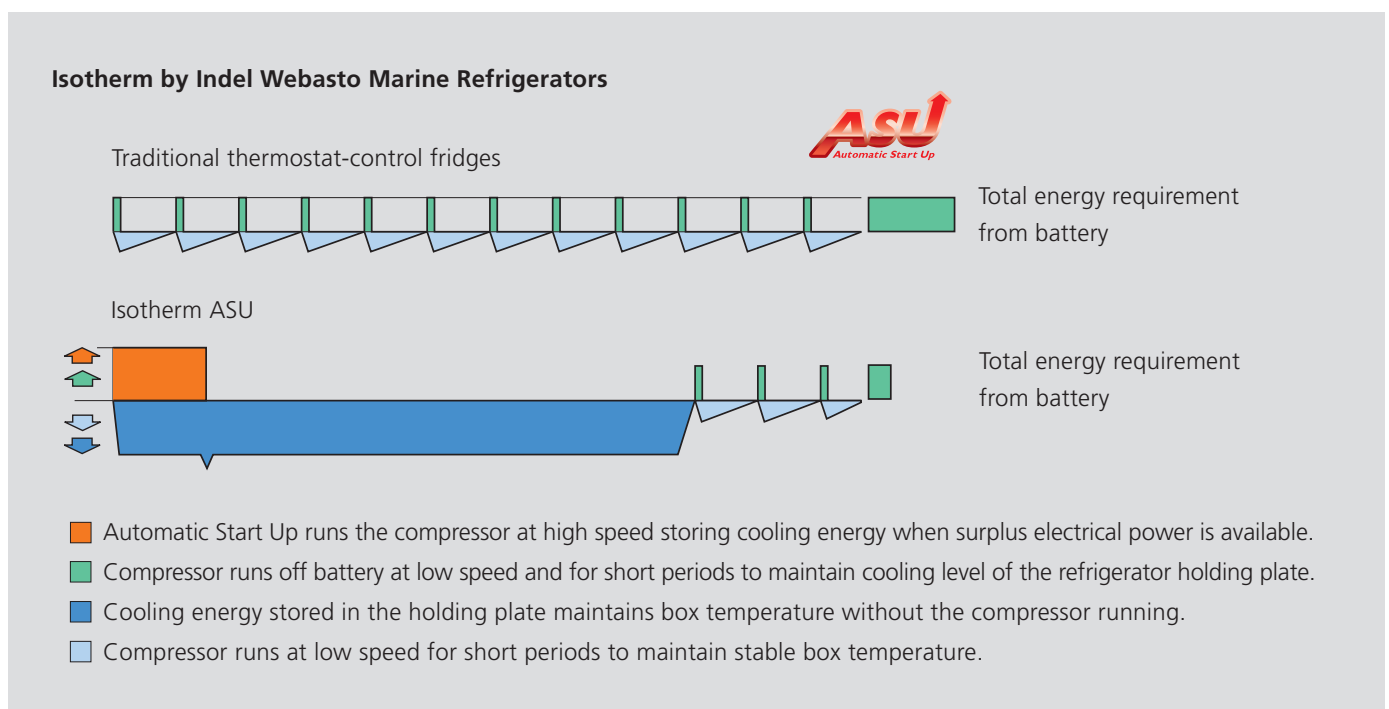

# Cooling Technology

## Frost-free technology



### Frost-free – Award winning technology

The Indel Webasto Marine frost-free concept is based on an intelligent principle that prevents the accumulation of ice inside the freezer thus keeping energy consumption low. All models equipped with the frost-free concept are extremely economical and save energy on board.

### The advantages of the frost-free concept:

- Exclusive Indel Webasto Marine technology for the marine market
- No ice accumulation for an excellent efficiency increase
- Exceptional cooling achievement: the refrigerator and the freezer reach the set temperature faster
- Stable inside temperature
- Manual defrosting becomes redundant
- No more unpleasant water pools resulting from incorrect manual defrosting



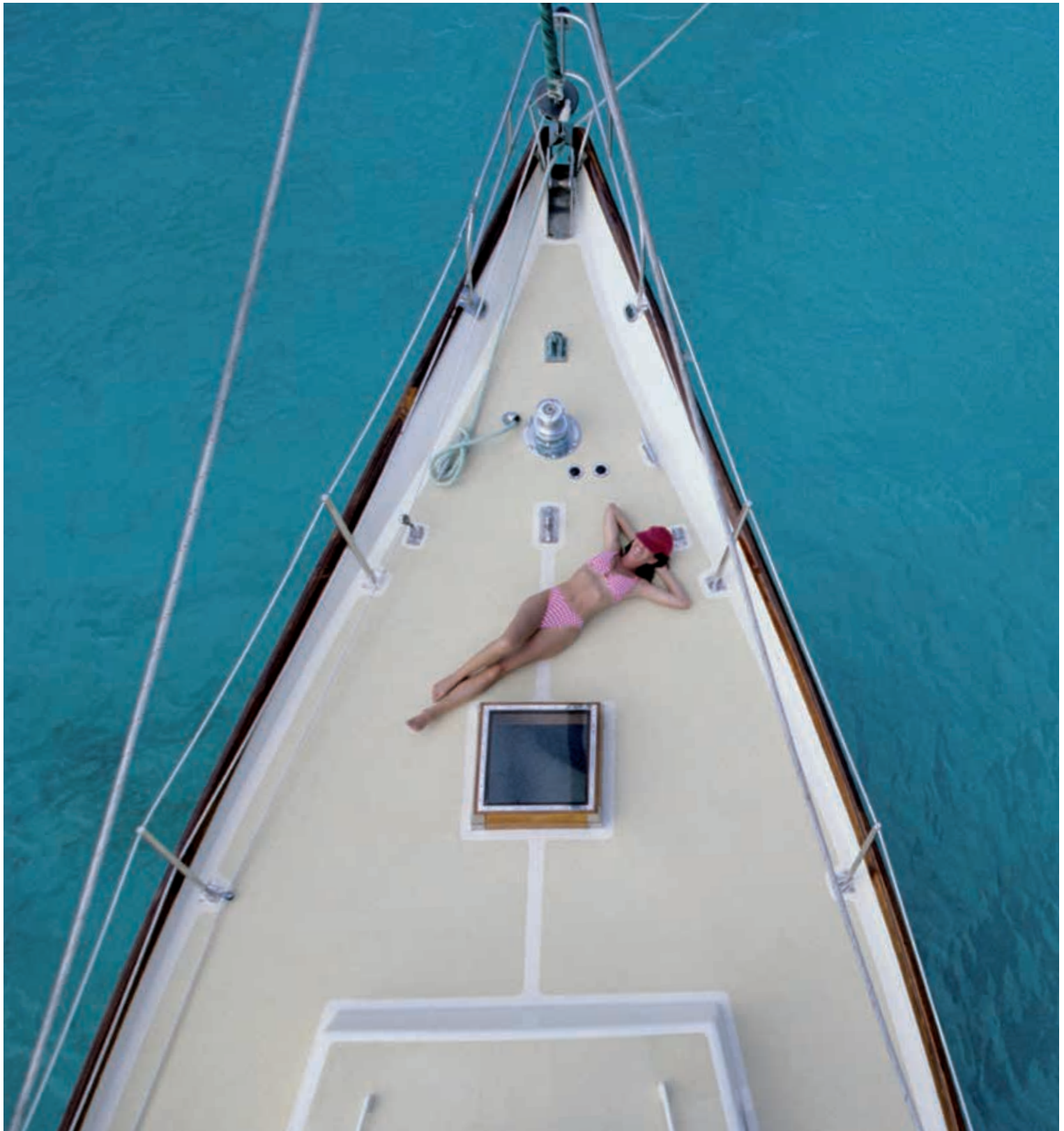

## Isotherm Cooling Units

Indel Webasto Marine provides different solutions for best cooling performances using air or seawater for efficient heat removal. Furthermore two model ranges, the thermostat controlled Compact range and the patented storage range ASU provide the best product for every use.

# Cooling Units

## **Compact**

**64**

Air-cooled

Water-cooled SP

Water-cooled Magnum

---

## **ASU**

**65**

Air-cooled

Water-cooled SP

Water-cooled Magnum

---



# Isotherm Cooling Units

## Compact

### Two approaches to provide perfect cooling for every requirement:

Indel Webasto Marine provides you with two product ranges of high-quality cooling units:

#### Compact

The Compact thermostat-regulated refrigeration unit uses a Secop compressor to cool an evaporator fitted in your refrigerator or deep freezer box.

The Secop compressors are even more power efficient. Hermetically sealed, they operate in a mixture of oil and refrigerant which contributes to extremely quiet running and very little material fatigue. All compressors used for Isotherm applications run on a three-phase electric system, just as all other high efficiency electric engines.

The three-phase current is created in a small microprocessor. In this "computer" Indel Webasto Marine has been able to program a number of functions which check and control many of the unit systems. This allows achieving the lowest possible power consumption. The same compressor is used for both 12 V and 24 V systems, and the electronic unit is able to protect itself from accidental reversal of the voltage polarity.





# Isotherm Cooling Units

## ASU

The ASU technology detects when a surplus of power is available, uses this power to freeze the cooling plate which consequently stores the cold for times, when no power is available for cooling purposes. A high-quality Secop compressor builds the core of the patented ASU "Automatic Start Up" electronic control system. Together with the Isotherm holding plate they are an unbeatable combination.

### How much power is needed?

#### This is the most frequently asked question of all.

We can give exact power consumption figures for our range of refrigerators, freezers and boxes, as we know their size and quality of insulation. It is more difficult to quote a figure for

self-installed refrigeration boxes as we do not know the exact size of the box, or even more important, the quality and thickness of the insulation material used.

### ASU

The intelligent refrigerator charges the holding plate while the engine is running by means of the patented energy management system.



### Practical click-on mounting bracket



A practical click-on mounting bracket suitable for horizontal or vertical wall installation, is included in all models except the AC/DC and the Magnum models.



Fasten the bracket and lift the compressor into place.



„Click“! The compressor locks onto the bracket without adjustments or tools.

# Isotherm Cooling Units

---

## Three possible cooling systems

Indel Webasto Marine provides a wide range of cooling units to suit every demand. For efficient heat removal various methods can be applied. Isotherm cooling units use air or seawater to eliminate the heat.



### Self-pumping sea water-cooled

The Isotherm SP units cool with the use of seawater. This method has the advantage that the heat exchange is made via a water cooled condenser. The water-cooled Isotherm SP operates consistently at an extremely high level of efficiency. Without fans or pumps to remove the heat generated by the condenser, the SP system consumes less battery power and is remarkably quiet.

The Isotherm SP unit uses the movements of the hull to draw heat down and out through a special fitting in the galley sink drain hose. The flow is completely free inside the draining hose, so each movement of the surrounding water produces a similar quantity of water level inside the hose, which results in pumping an equivalent amount of water in and out. By designing a special hull fitting containing a non restricting, fullflow spiral heat exchanger for cooling the heated refrigeration agent, an extremely efficient cooling system is created.

As the hull fitting is situated away from the boat's center of gravity, the smallest movement of the hull or mast of sailing boat is sufficient to create a pumping action. This movement results in constant withdraw of warm water and intake of cold water which also prevents fouling.



- Sea water cooling for even higher efficiency
- Lower power consumption
- Silent – no fan nor pumps
- Heat removed by sea water (max. temperature 28°C)
- No extra holes in hull required
- Simple to fit. Replaces the through-hull fitting for galley sink



### **Air-cooling**

Using air which is blown through the condenser by a fan is the traditional way to remove the heat. It is important that the compressor compartment is well ventilated allowing cold air to enter from below and hot air to escape to the top.



### **Isotherm Magnum – Seawater cooled electric pump**

Isotherm Magnum units are especially designed for vessels with exceptionally high refrigeration requirements, for example vessels sailing in tropical waters. Isotherm Magnum uses the surrounding water to increase cooling efficiency. All Magnum models are fitted with integral seawater pumps for circulating the cooling water through the cooling section of the refrigerator compressor. The pump is quiet, self-priming, withstands dry running and is self-aerating. The highly efficient heat exchanger is manufactured in a corrosion-resistant copper-nickel alloy and fitted with a zinc anode. Sea water-cooled units are extremely efficient and offer increased cooling capacity.

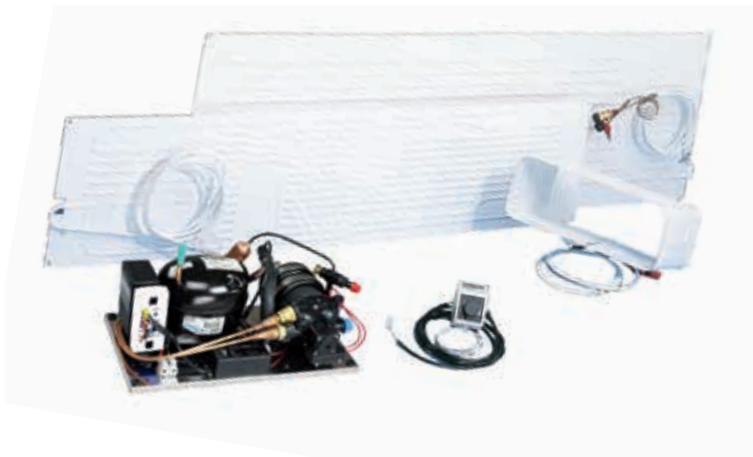

# Cooling Units

---

## Cooling Units Compact:

The compact cooling units use air or seawater to remove the heat. They are available in a wide variety to offer solutions for any demand.

### Air-cooled



- Fridge versions or freezer versions available
- 12/24 V Secop compressor
- Universal kit AC/DC optional for a complete power supply compatibility (12/24 V, 230/115 V and 50/60 Hz)
- Easy installation thanks to "click-on" system on DC models

### Water-cooled self pumping – SP



- Fridge versions or freezer versions available
- 12/24 V Secop compressor
- Universal kit AC/DC optional for a complete power supply compatibility (12 / 24 V, 230/115 V and 50/60 Hz)
- Easy installation thanks to "click-on" system on DC models
- SP system (patented) to reduce the noise of a ventilated condenser and reach a lower power consumption

### Water-cooled – Magnum



- Fridge versions or freezer versions available
- 12/24 V Secop compressor
- Universal kit AC/DC optional for a complete power supply compatibility (12/24 V, 230/115 V and 50/60 Hz)
- Self-priming sea water pump to ensure extra high efficiency for tropical applications
- Variable speed water pump according to the temperature of the water circulating inside the condenser



## Technical Data:

Type	Max. Volume (l)		Dimensions evaporator W x H x D (mm)	Dimensions compressor W x H x D (mm)	Weight (kg)	Secop Compressor type	Temperature range*
	Fridge	Freezer					
<b>Air-cooled</b>							
GE 80	80	26	350 x 250	280 x 160 x 175	9	BD35F	Fridge or Freezer**
GE 150	150	50	386 x 361	280 x 160 x 175	9	BD35F	Fridge or Freezer**
2001	125	41	240 x 85 x 210	280 x 160 x 175	9	BD35F	Fridge or Freezer**
2301	150	50	320 x 100 x 230	280 x 160 x 175	9	BD35F	Fridge or Freezer**
2501	200	66	380 x 140 x 270	330 x 160 x 175	9	BD50F	Fridge or Freezer**
2005	60	20	350 x 130	280 x 160 x 175	9	BD35F	Fridge or Freezer**
2007	100	33	250 + 110 x 350	280 x 160 x 175	9	BD35F	Fridge or Freezer**
2010	125	41	400 + 170 x 210	280 x 160 x 175	9	BD35F	Fridge or Freezer**
2012	170	56	815 x 210	330 x 160 x 175	11	BD50F	Dual
2016	200	66	1200 x 190	330 x 160 x 175	12	BD50F	Dual
2017	260	86	1000 x 270	330 x 160 x 175	12	BD50F	Dual
2013	400	133	1370 x 300	330 x 160 x 175	12	BD50F	Dual
<b>Seawater-cooled</b>							
<b>SP</b>							
2051	125	41	240 x 85 x 210	220 x 140 x 165	11	BD35F	Fridge or Freezer**
2351	150	50	320 x 100 x 230	220 x 140 x 165	11	BD35F	Fridge or Freezer**
2551	200	66	380 x 140 x 270	220 x 140 x 165	13	BD50F	Fridge or Freezer**
2055	60	20	350 x 130	220 x 140 x 165	10	BD35F	Fridge or Freezer**
2057	100	33	250 + 110 x 350	220 x 140 x 165	10	BD35F	Fridge or Freezer**
2050	125	41	400 + 170 x 210	220 x 140 x 165	11	BD35F	Fridge or Freezer**
2553	170	56	815 x 210	220 x 140 x 165	13	BD50F	Dual
2554	200	66	1200 x 190	220 x 140 x 165	13	BD50F	Dual
2555	260	86	1000 x 270	220 x 140 x 165	13	BD50F	Dual
2556	400	133	1370 x 300	220 x 140 x 165	14	BD50F	Dual
<b>Magnum</b>							
2505	200	66	380 x 140 x 270	420 x 240 x 200	15	BD50F	Dual
2511	170	56	815 x 210	420 x 240 x 200	15	BD50F	Dual
2512	200	66	1200 x 190	420 x 240 x 200	15	BD50F	Dual
2513	260	86	1000 x 270	420 x 240 x 200	15	BD50F	Dual
2507	400	133	1370 x 300	420 x 240 x 200	16	BD50F	Dual
2607	425	141	1370 x 300	420 x 240 x 200	16	BD80F	Dual
2609	600	200	1500 x 460	420 x 240 x 200	17	BD80F	Dual
<b>NEW Air-cooled VE 150</b>							
VE 150	150	No Freezer	220 x 275 x 70	390 x 130 x 175	11	BD35F	Fridge

\* Temperatures range: from +2°C to -18°C. Reduce recommended box volume with 10 – 20% for tropical conditions. Specification changes may be made without prior notice. Dual can operate both as a fridge or as a freezer (-12°C), by setting the temperature with a special thermostat.

\*\* Specific part numbers, one for fridge version, another for freezer version.

# Compact Classic (air-cooled)

GE 80, GE 150, 2001, 2301



GE 80	
Evaporator	Flat
Max. Box Volume Fridge (l)	80
Max. Box Volume Freezer (l)	26



GE 150	
Evaporator	Flat
Max. Box Volume Fridge (l)	150
Max. Box Volume Freezer (l)	50



2001	
Evaporator	Small-O
Max. Box Volume Fridge (l)	125
Max. Box Volume Freezer (l)	41



2301	
Evaporator	Medium-O
Max. Box Volume Fridge (l)	150
Max. Box Volume Freezer (l)	50

# Compact Classic (air-cooled)

2501, 2005, 2007, 2010



2501	
Evaporator	Large-O
Max. Box Volume Fridge (l)	200
Max. Box Volume Freezer (l)	66



2005	
Evaporator	Small-Flat
Max. Box Volume Fridge (l)	60
Max. Box Volume Freezer (l)	20



2007	
Evaporator	Small-L
Max. Box Volume Fridge (l)	100
Max. Box Volume Freezer (l)	33



2010	
Evaporator	Large-L
Max. Box Volume Fridge (l)	125
Max. Box Volume Freezer (l)	41

# Compact Classic (air-cooled)

2012, 2016, 2017, 2013



2012	
Evaporator	Flat
Max. Box Volume Fridge (l)	170
Max. Box Volume Freezer (l)	56



2016	
Evaporator	Flat
Max. Box Volume Fridge (l)	200
Max. Box Volume Freezer (l)	66



2017	
Evaporator	Flat
Max. Box Volume Fridge (l)	260
Max. Box Volume Freezer (l)	86



2013	
Evaporator	Large-Flat
Max. Box Volume Fridge (l)	400
Max. Box Volume Freezer (l)	133



# Compact Classic (seawater-cooled, SP)

2051, 2351, 2551, 2055



2051	
Evaporator	Small-O
Max. Box Volume Fridge (l)	125
Max. Box Volume Freezer (l)	41



2351	
Evaporator	Medium-O
Max. Box Volume Fridge (l)	150
Max. Box Volume Freezer (l)	50



2551	
Evaporator	Large-O
Max. Box Volume Fridge (l)	200
Max. Box Volume Freezer (l)	66



2055	
Evaporator	Small-Flat
Max. Box Volume Fridge (l)	60
Max. Box Volume Freezer (l)	20

# Compact Classic (seawater-cooled, SP)

2057, 2050, 2553, 2554



2057	
Evaporator	Small-L
Max. Box Volume Fridge (l)	100
Max. Box Volume Freezer (l)	33



2050	
Evaporator	Large-L
Max. Box Volume Fridge (l)	125
Max. Box Volume Freezer (l)	41



2553	
Evaporator	Flat
Max. Box Volume Fridge (l)	170
Max. Box Volume Freezer (l)	56



2554	
Evaporator	Flat
Max. Box Volume Fridge (l)	200
Max. Box Volume Freezer (l)	66

# Compact Classic (seawater-cooled, SP)

2555, 2556



2555	
Evaporator	Flat
Max. Box Volume Fridge (l)	260
Max. Box Volume Freezer (l)	86



2556	
Evaporator	Large-Flat
Max. Box Volume Fridge (l)	400
Max. Box Volume Freezer (l)	133

## Air-cooled VE 150



VE 150	
Evaporator	275 x 220 x 70
Max. Box Volume Fridge (l)	150
Max. Box Volume Freezer (l)	NO

- Quick and easy installation
- Rapid cooling capability (fridge functionality up to 150 liters)
- Very compact dimensions
- High quality materials
- Efficient fin evaporator
- Fan for excellent cold air distribution

# Compact Classic (seawater-cooled, Magnum)

2505, 2511, 2512, 2513

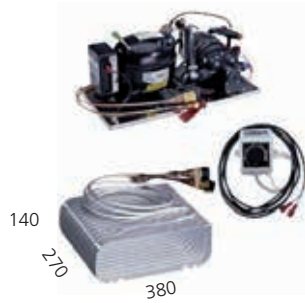

2505	
Evaporator	Large-O
Max. Box Volume Fridge (l)	200
Max. Box Volume Freezer (l)	66



2511	
Evaporator	Flat
Max. Box Volume Fridge (l)	170
Max. Box Volume Freezer (l)	56



2512	
Evaporator	Flat
Max. Box Volume Fridge (l)	200
Max. Box Volume Freezer (l)	66



2513	
Evaporator	Flat
Max. Box Volume Fridge (l)	260
Max. Box Volume Freezer (l)	86

# Compact Classic (seawater-cooled, Magnum)

2507, 2607, 2609

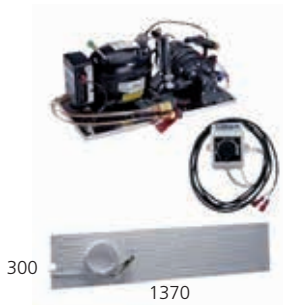

2507	
Evaporator	Large-Flat
Max. Box Volume Fridge (l)	400
Max. Box Volume Freezer (l)	133

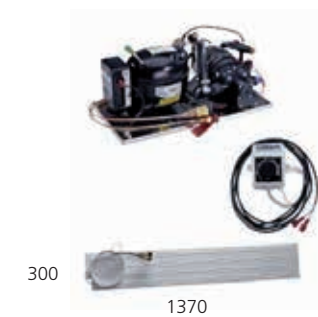

2607	
Evaporator	Large-Flat
Max. Box Volume Fridge (l)	425
Max. Box Volume Freezer (l)	141

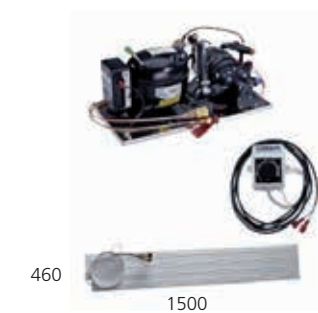

2609	
Evaporator	Jumbo-Flat
Max. Box Volume Fridge (l)	600
Max. Box Volume Freezer (l)	200



# Cooling Units

## Automatic Start Up (ASU)

---

### Automatic Start Up (ASU)

The ASU cooling units are also available in air-cooled or seawater-cooled models. Equipped with the patented ASU technology they offer an innovative energy management system to the user.

#### Air-cooled



- Fridge versions or freezer versions (-6°C) available
- 12/24 V Secop compressor
- Kit AC/DC optional for a complete power supply compatibility (12/24 V, 230/115 V and 50/60 Hz)
- Easy installation thanks to "click-on" system

#### Water-cooled self pumping – SP



- Fridge versions or freezer versions (-6°C) available
- 12/24 V Secop compressor
- Kit AC/DC optional for a complete power supply compatibility (12/24 V, 230/115 V and 50/60 Hz)
- Easy installation thanks to "click-on" system
- SP system (patented) to reduce the noise of a ventilated condenser and reach a lower power consumption
- The perfect combination for sailing yachts



# Cooling Units

## Automatic Start Up (ASU)

### Water-cooled – Magnum



- Fridge or freezer (-6°C) use
- 12/24 V Secop compressor
- Dedicated kit AC/DC optional for a complete power supply compatibility (12/24 V, 230/115 V and 50/60 Hz)
- Self-priming seawater pump to ensure extra high efficiency for tropical applications
- Variable speed water pump according to the temperature of the water circulating inside the condenser

### Technical Data:

Type	Max. Volume (l)		Dimensions holding plate W x H x D (mm)	Dimensions compressor W x H x D (mm)	Weight (kg)	Secop Compressor Type	Temperature range*
	Fridge	Freezer					
ASU							
Air-cooled							
3201	125	40	300 x 210 x 60	280 x 160 x 175	14	BD35F	Fridge or Freezer**
3701	200	65	355 x 280 x 60	330 x 160 x 165	16	BD50F	Fridge or Freezer**
Sea water-cooled							
SP							
3251	125	40	300 x 210 x 60	220 x 140 x 165	15	BD35F	Fridge or Freezer**
3751	200	65	355 x 280 x 60	220 x 140 x 165	17	BD50F	Fridge or Freezer**
Magnum							
4201	200	65	355 x 280 x 60	420 x 240 x 200	19	BD50F	Fridge or Freezer**
4701	240	80	355 x 280 x 90	420 x 240 x 200	20	BD50F	Fridge or Freezer**
4901	400	130	530 x 325 x 117	420 x 240 x 200	23	BD80F	Fridge or Freezer**
5302	260	85	355 x 280 x 90	420 x 240 x 200	21	BD80F	Fridge or Freezer**
5802	325	105	400 x 320 x 90	420 x 240 x 200	22	BD80F	Fridge or Freezer**

\* Temperatures range: from +2°C to -6°C. We recommend reducing the box volume by 10 – 20 %, in tropical conditions. Specification changes may be made without prior notice  
 \*\* Specific part numbers, one for fridge version, another for freezer version

# Automatic Start Up (ASU)

Air-cooled units – Seawater cooled SP

3201 / 3701 / 3251 / 3751

## Automatic Start Up (ASU) air-cooled units



3201	
Compressor Type	BD35F
Max. Box Volume Fridge (l)	125
Max. Box Volume Freezer (l)	40



3701	
Compressor Type	BD50F
Max. Box Volume Fridge (l)	200
Max. Box Volume Freezer (l)	65

## Automatic Start Up (ASU) seawater cooled SP



3251	
Compressor Type	BD35F
Max. Box Volume Fridge (l)	125
Max. Box Volume Freezer (l)	40



3751	
Compressor Type	BD50F
Max. Box Volume Fridge (l)	200
Max. Box Volume Freezer (l)	65



# Automatic Start Up (ASU)

Seawater cooled – Magnum

4201 / 4701 / 5302 / 5802 / 4901

## Automatic Start Up (ASU) seawater cooled – Magnum



4201	
Compressor Type	BD50F
Max. Box Volume Fridge (l)	200
Max. Box Volume Freezer (l)	65



4701	
Compressor Type	BD50F
Max. Box Volume Fridge (l)	240
Max. Box Volume Freezer (l)	80



5302	
Compressor Type	BD80F
Max. Box Volume Fridge (l)	260
Max. Box Volume Freezer (l)	85

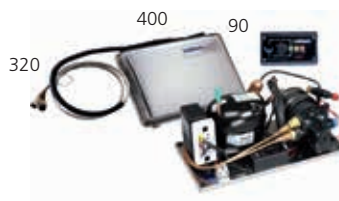

5802	
Compressor Type	BD80F
Max. Box Volume Fridge (l)	325
Max. Box Volume Freezer (l)	105



4901	
Compressor Type	BD80F
Max. Box Volume Fridge (l)	400
Max. Box Volume Freezer (l)	130

# Build your own cooler box!

Build a box into your boat. It's not difficult at all! Most boats have one thing in common. They have very few right angles or regular shaped compartments. This often makes it difficult to find space for a fridge or cooler. But no worries. Indel Webasto Marine offers do it yourself refrigeration or freezing boxes!

Indel Webasto Marine can supply a flat-pack set of ready-cut insulated panels to help build a customised box. The panels are covered on both sides with 2.5 mm plastic laminate of foodstuff quality and have 46 mm thick closed cell foam insulation in between. They are easy to cut and glue together using a polyurethane sealant or mould resistant silicone resulting in joints that are leak-proof but not totally inflexible.

The kit REF. SCD00001AA, consists of three insulation panels measuring 978 x 478 x 50 mm, cover strips for the edges of the lid as well as a user-friendly instruction manual.

Cooling evaporators are available in a number of designs: the O-shaped serves for freezer compartments but requires slightly more space. The L- and flat-shaped can be bent to fit the box. These require less space and produce a slightly more even temperature distribution in the box, but do not have a freezer compartment. The evaporators can be fitted in any position. They are delivered with 2 meter pipes, have quick-couplings and require an installation opening of not more than  $\varnothing$  30 mm in the refrigerator wall. The desired temperature is adjusted with a thermostat. A cooling and ventilation fan is fitted to all our air-cooled models for highest efficiency.

## Find the right evaporator:

Isotherm Large and Jumbo evaporators have extra large freezing surface that can be bent so that cooling energy can be radiated from all four sides. The Isotherm Magnum model is available with a holding plate suitable for freezer and adjustable to  $-6^{\circ}\text{C}$ , but it produces less stable temperature compared to the radiation type evaporator.

To achieve stable freezing temperatures within the box, we recommend the powerful Large or Jumbo evaporators. To determine the ideal size of evaporator for your boat, divide the recommended maximum volume by three. The size of evaporator should be chosen under the consideration to have at least two mounted to the sides of the box. The evaporator, which is made of malleable aluminum enabling it to be shaped to perfectly fit the inside of most of the boxes, (please always refer to our installation manual for detailed information), is available for freezers of up to 175 liters. Always specify the final use of the unit (fridge or freezer use).

Temperature is regulated with a traditional thermostat. For high-efficiency freezing, large covering evaporators are required. The ASU feature is not recommended in this application.

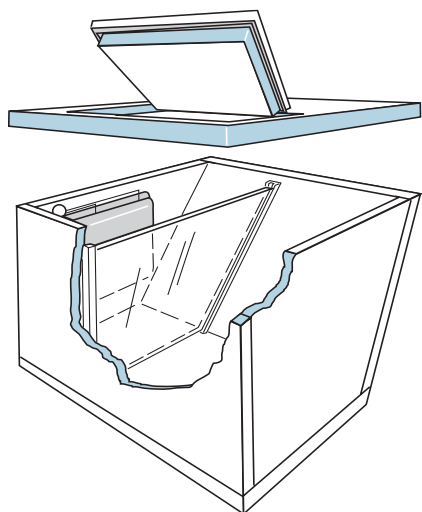

### Cooling Units Accessories:

Picture	Order Number	Description
	SEH00004HA	Power pack 110/240 V AC 47/63 Hz IN 24 V DC 4,2 A OUT for BD35F/BD50F
	SEC00003DA	Internal light kit 12 – 24 V
	SBE00004AA	Air hose adapter kit Ø 106 mm (l = 1.500 mm)
	SGE00012AA	"Click-on" bracket for an easy compressor' installation
	SEA00076DA	High speed Thermostat kit for freezers
	SBD00031AA	Extension tube with couplings (l = 1 m)
	SBD00032AA	Extension tube with couplings (l = 2 m)
	SBD00033AA	Extension tube with couplings (l = 3 m)
	SBE00006AA	Zinc anode for sea water-cooled SP units
	SBE00008AA	Zinc anode, 3/8", for sea water-cooled Magnum units

\* Included in SP, option for air-cooled units and does not fit Magnum models

Picture	Order Number	Description
	SGC00005AA	Evaporator door O-SMALL
	SGC00004AA	Evaporator door O-MEDIUM
	SGC00003AA	Evaporator door O-BIG
	SEA00004DB	Double thermostat kit, 10 °C to -20 °C
	SFD00008AA	Skin fitting valve kit for SP units
	SBE00071CA	Air circulation fan
	SGC00152AA	Foldable bottle rack
	SGC00006AA	Ice cube kit for holding plate (ASU system)
		The ASU system is controlled from a special control panel. Switch to 'Normal/Auto' and this unique system operates in fully-automatic mode maintaining the correct temperature at an absolute minimum battery load. If battery power management is not vital – as when connected to shore-power or running on solar panels – the 'Man/Temp' mode can be selected and temperature adjusted manually by turning the dial on the panel.
		Isotherm ASU is delivered as a complete do-it-yourself kit. Everything is pre-filled and ready-to-go. The cold-holding plate and compressor are connected together by quick-fit couplings that can be connected and disconnected at will. This allows us to thoroughly test all units during production ensuring the highest possible quality. Cables and connectors are of telephone-type.

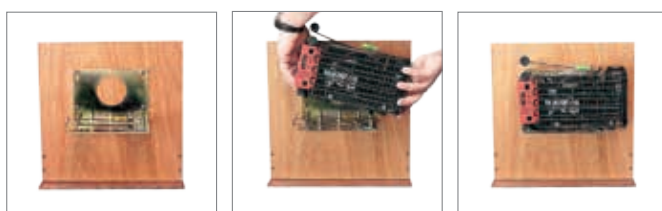

A practical "click-on" mounting bracket suitable for horizontal or vertical mounting is included in all models except the AC/DC and the Magnum models. Fasten the bracket and lift the compressor into place.

'Click'! The compressor locks onto the bracket without adjustments or tools.

# Special Design

## Refrigerators and Freezers

---

For perfect integration into the interior design of the boat, Indel Webasto Marine products must offer a high level of customization options. This aspect allows for unusual installations and extraordinary design.

Projects are executed in close cooperation with customers. Indel Webasto Marine conducts a comprehensive study to determine the technical requirements.



**Customized solutions to fit  
any size, shape and demand!**



Indel Webasto Marine offers tailored refrigeration and freezer solutions to meet customer needs even on very complex projects. The project is realized in close cooperation between the shipyard and Indel Webasto Marine. Indel Webasto Marine conducts a complete study to determine the best solution which fits both economic and technical constraints. Do not hesitate to contact us for more detailed information.

### Product Specifications:

- Completely tailored solutions
- Overall compatibility with the boat's interior design
- The custom-built approach in the product study assures an easy installation of the unit as well as an excellent effect on board
- Production technology is chosen according to the customer's request (small quantity, glass fiber boxes, high quantity, rotomoulding technology)





## Produce fresh ice on board

Serving drinks on board is great. But being able to serve them with ice cubes is even better. Indel Webasto Marine now provides boat owners with the perfect solutions to produce fresh ice on board.

# Ice-Makers

IceDrink Clear	88
IceDrink White	88
IceDrink White Low Profile	89
IceDrink White BI29	89

# Ice Makers

---

Serving drinks on board is great. But being able to serve them with ice cubes is even better. Indel Webasto Marine now provides boat owners with the perfect solutions to produce fresh ice on board. What's more, by offering different models with different technologies, customers can choose between clear ice and white ice.



### Convincing facts for the Isotherm IceDrink Clear:

- Complete stainless steel design
- Production capacity of 18 kg per day
- Spray technology for clear ice
- Available both in 115 V 60 Hz and 230 V 50 or 60 Hz
- Quality cubes: compact, cold and crystalline that drop into the collection bin, (not refrigerated), meeting the ice requirements even at peak demand times
- Front to rear ventilation
- Three flange options for critical space installations



- For the supply of mineral water, a 15 liter water tank operating with a 230 V or 115 V water pump can be ordered as an accessory (for IceDrink Clear only)
- Dimensions: 140 x 380 x 290 mm



### Convincing facts for the Isotherm IceDrink White:

- Available in stainless steel or with white door
- Production capacity of 8 kg per day
- Reliable white ice technology
- Various customization possibilities for different installations just like with the CRUISE classic fridges and freezers
- Front ventilation only
- Refrigerated collection bin to keep the ice cubes frozen





**Convincing facts for the Isotherm IceDrink White Low Profile:**

Rear position compressor for a low height profile Ice Maker

- Reliable performing technology, ice production 8 kg per day
- Refrigerated cabinet to store and maintain frozen ice cubes
- High quality stainless steel for outer cockpit applications
- Refined flush installation thanks to a flush 3 sides mounting frame with the 4th one as option
- Exclusive designed condensing forced ventilation to grant maximum performances in hot conditions
- Extra compact dimensions in height
- Ideal for installation in critical areas where the height is limited

**Convincing factors for the Isotherm IceDrink White BI29:**

- Sturdy built in design casing
- Stainless steel inner-lining and plastic bottom section
- Ice-production capacity of 4 kg per day
- Extra low profile, to easily fit in cockpit applications or below seats
- Equipped with extra-long roller slides, to use the box as a drawer



**Product Overview: Isotherm IceDrink Ice Makers**

Type	Gross volume (l)	Dimensions H x W x D (mm)	Weight (kg)	Power consumption	Power Supply (Volt/Hz)
IceDrink Clear	4	584 x 355 x 430	29	320 Watt	230 V AC - 50Hz or 115 V AC - 60 Hz
IceDrink White, White Door	12	630 x 355 x 420*	26	180 Watt	230 V AC - 50 Hz
IceDrink White Inox	12	630 x 375 x 460**	27	180 Watt	230 V AC - 50 Hz
IceDrink White Low Profile	12	475 x 375 x 630	26	180 Watt	230 V AC - 50Hz or 115 V AC - 60 Hz
IceDrink White BI29	14	375 x 363 x 730	26	180 Watt	230 V AC - 50Hz or 115 V AC - 60 Hz

\* Door thickness (to be added): 440 mm      \*\* Width IceDrink White Inox frame 20 mm per side





## Serve wine or champagne at the perfect temperature

Indel Webasto Marine offers its customers the opportunity to have wine cooler and cellars on board. This high class equipment enables boat owners to serve and store great wine or champagne at the perfect temperature.

## **Wine Cellars & Cooler**

<b>Wine Cooler Divino The One</b>	<b>92</b>
<hr/>	
<b>Wine Cellar Divino 23</b>	<b>93</b>
<hr/>	
<b>Wine Cellar Divino 35</b>	<b>93</b>
<hr/>	

# Divino Wine Cellars & Cooler

## Divino The One

### Divino The One: serve great wine or champagne.

Divino The One is an integrated wine cooler that keeps wine perfectly chilled during service.

It's extremely simple to use: just touch any part of the crown with your finger to activate your Divino The One. Touch and serve your wine always at the right temperature.

The Divino The One is based on a powerful thermoelectric core unit that creates an instant cold air jacket around the bottle.

Once integrated, the only visible part will be the stainless steel crown, capable to match the typical marine-style applications.

### Using it will make your wine tasting more fun!

Tap the crown three times and scroll through the colour selection of 27 options to personalize it.

By tapping four times the crown, the illumination will gently fade through the full colour selection.

- Perfect serving temperature for your wine
- Elegant integrated design
- Jacket of cold air: no more wet bottles and water stains
- Performing and reliable: 3 years warranty, maintenance free



### The One – a brief tour

#### Smart-touch crown

- Control with just a touch
- Crafted from stainless steel
- Seamless edge-to-edge curve
- Polished to a mirror finish (not plated)
- No buttons or displays needed

#### Interactive LED lighting

- 27 colours
- Select colour using touch
- Option to use without light
- Colour fade mode

#### Bottom threaded ring included in the supply



#### Simple installation

- Ideal for inner and outer cockpit application
- Does not require specialist installation
- Install into a 154 mm hole
- Super compact: 160 mm wide, 300 mm deep
- Low power, uses only 60 W
- DC as standard, AC-DC kit available as optional

#### Patented Kryolux™ Technology

- Completely dry cooling
- No ice, water, CFCs or other refillables
- Caters for extra wide 75 cl bottles
- Automatic standby after 2 hours
- Runs silently

# Divino Wine Cellars & Cooler

## Divino 23, Divino 35



### Divino 23 & Divino 35: safe on board storage for wine and champagne.

Both 23 and 35 bottle wine cellars can be built into the dressers or columns of modular furniture with no modification of its design. For a perfect integration, the profile of the door is totally lined up with the doors of the furniture.

Both models feature double door locking systems to prevent unwanted door opening in rough seas and special racks designed for storing champagne bottles.

- Sturdy metal casing
- Robust handle
- Big storage room for 23 or 35 bottles
- Additional door lock included in the supply

### Enjoy the pure luxury of storing wine or champagne at the perfect temperature:

- Built-In wine cellars for 23 or 35 bottles
- No aeration grills needed
- Profile of the door totally lined up with the doors of the furniture
- Interior light



Divino 23



Divino 35

### Product Overview: DIVINO Wine Cellars & Cooler

	Divino The One	Divino WC 23	Divino WC 35
Capacity	One	23 (27 max.)* bottles	35 (45 max.)* bottles
Internal shelves	N/A	3 wooden	5 wooden
Size in mm (H x W x D)	300 x 152 x ø 160	455 x 560 x 550	680 x 560 x 550
Dimensions door in mm (H x W)	N/A	460 x 588	715 x 588
Weight (kg)	3,2	36	38
Power installed	60 Watt	230 V 120 Watt - 115 V 120 Watt	230 V 120 Watt - 115 V 120 Watt
Cooling system	Thermoelectric	Compressor CFC – free	Compressor CFC – free
Electronic thermostat	Self Regulation	1	1
Temperature	Mono	mono	mono
Internal light	27 Color Option	yes	yes

\* 27 or 45 bottles if all the wooden shelves are removed from the wine cellar



## Ensure warm water supply on board

Isotemp water heaters are specifically designed for use on yachts and boats. Only high quality components are chosen to ensure the best product performance. The marine water heaters are very robust and highly insulated to keep warm water available at all times and under all circumstances.

## Water heaters

<b>Basic</b>	<b>97</b>
<hr/>	
<b>Slim</b>	<b>97</b>
<hr/>	
<b>Square</b>	<b>97</b>
<hr/>	
<b>NEW Spa</b>	<b>99</b>
<hr/>	





# Marine Water Heaters

## Basic, Slim and Square



Isotemp water heaters are specifically designed for use on yachts and boats. Only high quality components are chosen to ensure the best product performance.

### Isotemp Water Heaters Slim and Basic

Isotemp premium water heater comes with brushed stainless steel cover as well as innovative internal design. It achieves highest capacity by optimized installation of the engine water heat exchanger as well as the immersion heater. They are positioned in the lowest part of the tank where the water is coldest in order to ensure an equal heating of all the water in the tank. The water in and outlets are especially designed to minimize the mixture of cold and hot water.

Indel Webasto Marine introduces two water boilers. These units are equipped with a specific, anti-flare 115 V/750 W or 230 V/750 W heating element which is applied, for time being, on two models of our range: Basic 24 L and Slim 25 L. Anti-flare water heaters are necessary if their installation is foreseen in engine rooms of boats with gasoline engines.



- Robust design
- Water tank in stainless steel
- External cylinder in stainless steel
- Stable fixing feet in stainless steel
- 360° adjustable mounting for easy installation also on bulkhead

### Product Specifications:

- Extra long, corrugated coils for high heat exchange efficiency
- Special 7.0 bar / 100 psi safety valve: simple winter drain
- Ultra-thick insulation for lowest temperature loss
- Electrical plug and play immersion heating element, especially designed to heat also the water at the bottom of the tank
- Thermostat mixing valve (optional on Square and Double coil water heaters)
- 750 W immersion heating element as standard; 1200 W available as an option only for Slim 20 and 25, Basic 40, 50 and 75
- 2000 W heating element is available as an option only for Slim 25, Basic 50 and 75. It is compatible on 230 V versions only

## Product overview: Marine Water Heaters

Article Number	Type	Gross volume (l)	Dimension* L x Ø D (mm)	Weight (kg)	Rated pressure (bar)	Heating element (V)	Nominal power (W)
601531S000003	Slim 15	15	520 x 295	9.0	7.0	230	750 std
						115	750 std
602031S000003	Slim 20	20	645 x 295	10.5	7.0	230	750 std or 1200
						115	750 std or 1200
602531S000003	Slim 25	25	765 x 295	12.0	7.0	230	750 std or 1200 or 2000
						115	750 std or 1200
602431B000003	Basic 24	24	470 x 395	12.5	7.0	230	750 std
						115	750 std
603031B000003	Basic 30	30	535 x 395	13.5	7.0	230	750 std
						115	750 std
604031B000003	Basic 40	40	640 x 395	15.5	7.0	230	750 std or 1200
						115	750 std or 1200
605031B000003	Basic 50	50	760 x 395	17	7.0	230	750 std or 1200 or 2000
						115	750 std or 1200
607531B000003	Basic 75	75	1050 x 395	24.5	7.0	230	750 std or 1200 or 2000
						115	750 std or 1200
<b>Anti-flare</b>							
602531S0000026	Slim 25	25	765 x 295	14.5	7.0	230	750 std
						115	750 std
602431B0000026	Basic 24	24	470 x 395	15.0	7.0	230	750 std
						115	750 std
<b>Square</b>			<b>Dimension W x D x H (mm)</b>				
601631QX00000	Square 16	16	400 x 180 x 560	15.5	5.0	230	750 std
						115	750 std
<b>Double coil</b>			<b>Dimension L x Ø D (mm)</b>				
602431BD00000	Basic 24	24	470 x 395	13.0	7.0	230	750 std
						115	750 std
604031BD00000	Basic 40	40	640 x 395	16.0	7.0	230	750 std or 1200
						115	750 std or 1200
607531BD00000	Basic 75	75	1050 x 395	25.0	7.0	230	750 std or 1200 or 2000
						115	750 std or 1200

\* Including thermostat mixing valve

\*\* Immersion heater 115 V / 750 W and 115 V / 1200 W also available. Material: Tank, engine water coil and all connections AISI 316; Outside cover and mounting feet: AISI 304; Electric immersion heater: Copper covered by Nickel; Insulation: Polyurethane; Water connections: 1/2" inside and outside NPT and BSP pipe thread. Changes of the specification may be done without prior notice



# Marine Water Heaters

The new Spa range!

**NEW**



The Isotemp Spa boilers are available in five different sizes ranging from 15 to 40 liters capacity. They match high marine quality standards such as a stainless steel inner tank, a robust polypropylene casing and a 6 bar safety valve.

## High Marine quality standards and optimized cost/ quality ratio!

- 5 different sizes from 15 to 40 liters capacity
- AISI 316 inner tank
- 6 bar safety valve
- Optional mixing valve
- Extra thick insulation for high performance
- Outer casing made of high quality polypropylene
- Customisable with valves, voltage and nominal power of the heating element
- Water connections: 1/2"



## Product overview: Marine Spa boilers

Article number	Type	Gross volume (l)	Dimension (Ø x L) (mm)	Weight (kg)	Rated pressure (bar)	Heating element (V)	Nominal power (W)
6P1531SPA0100	Spa 15	15	310 x 450±5	7.5	6	230	750 std
						115	750 std
6P2031SPA0100	Spa 20	20	310 x 550±5	9	6	230	750 std
						115	750 std
6P2531SPA0100	Spa 25	25	310 x 650±5	10	6	230	750 std or 1200
						115	750 std or 1200
6P3031SPA0100	Spa 30	30	390 x 535±5	12	6	230	750 std
						115	750 std
6P4031SPA0100	Spa 40	40	390 x 640±5	14	6	230	750 std or 1200
						115	750 std or 1200



## **Isotherm Air Heater – the perfect defrosting solution**

The air heater provides defrost power with radial fans and three power steps. It transfers the surplus of heat coming from the engine to defrost as well as to heat the cabin.

# Air Heat Exchangers

# Air Heat Exchangers

---

The Air Heat Exchanger transfers the surplus heat coming from the engine using it to defrost as well as to heat the cabin. It has a radial fan with three power steps. It is equipped with four 60 mm hose brackets for the warm air distribution.



- Four outlets with Ø 60 mm
- The air intake can be canalized with hose adapters
- Fan speed regulation
- 12 or 24 V versions available
- Casing in stainless steel
- High heat output of 10 kW
- High temperature resistant components

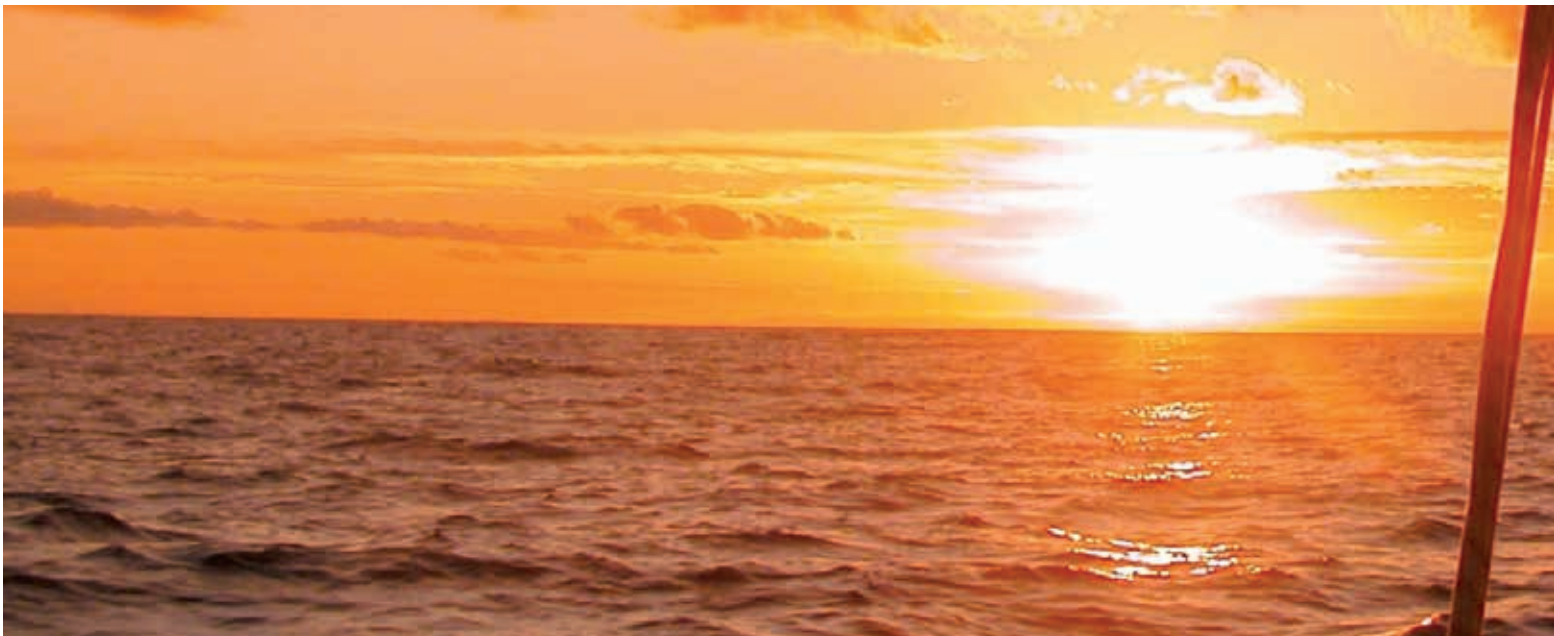

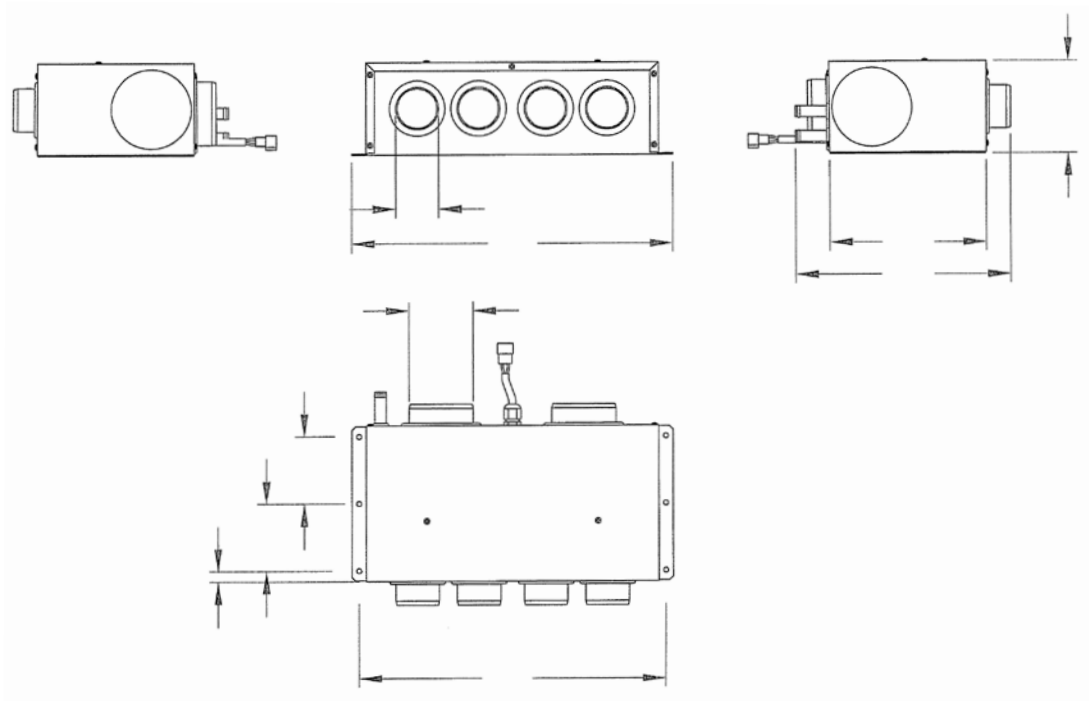

**Product overview: Air Heat Exchangers**

Article number	Heat output (kW)	Dimension H x W x D (mm)	Volt (V)	Water pressure (bar)	Water hose connection (mm - ")	Weight (kg)	Power consumption (W)			Air-flow (m <sup>3</sup> /H)
							Low	Medium	High	
6D01A1DH00000	10	135 x 450 x 300	12	2.5	16 - 5/8	5,5	45	54	84	Up to 500
6D02B1DH00000	10	135 x 450 x 300	24	2.5	16 - 5/8	5,5	45	54	84	Up to 500





## Ensure security on board

Boat owners using sophisticated and expensive, most technical equipment, create an increasing demand for security on board. On board safes ensure on board security.



## On Board Safes

Safe 10

106

---

Safe 30

106

---

# On Board Safes

---

Boat owners using sophisticated and expensive, most technical equipment, create an increasing demand for security on board. On board safes ensure on board security. The Isotherm safes are available in two sizes and two different materials: Inox (stainless steel) and painted steel. The larger model (Safe 30) is big enough to store a laptop computer. The smaller model (Safe 10) is sufficiently large to store smaller size electronics.



- Extra thick stainless steel AISI 304 of 5 mm
- Three independent locking systems  
(code number, mechanical, electronic key)
- Robust design
- Mounting bracket kit
- Plenty of space inside





Safe 30



Safe 10

- Steel painted with highly resistant grey coating
- Control panel integrated flush with the door
- Three independent locking systems  
(code number, mechanical, electronic key)
- Robust design
- Plenty of space inside

**Product overview: On Board Safes**

Article number	Type	Dimension H x W x D (mm)	Weight (kg)
7030000A00000	Safe 30 Safe security box big Inox	220 x 430 x 350	15
7F10000A00000	Safe 10 Safe security box small painted, flush door	170 x 300 x 231	5.85
7F30000A00000	Safe 30 Safe security box big painted, flush door	221 x 431 x 350	12.3



# Indel Webasto Marine – some references

---



*DRAWER 65 Inox*



*CRUISE 200 customized with wooden door*



*CRUISE 65 Inox*



*CRUISE 49 Inox*



*CRUISE 36 Black*



*Special design*





*CRUISE 49*



*Side by side installation of the CR 130 fridge and the CR 90 freezer Inox*



*DR 160 Custom Panel version*



*DR 160 Inox Light x 2 and Ice maker Clear Inox*









### **Indel Webasto Marine – Present all over the world!**

Indel Webasto Marine is the successful Joint Venture of Italian based IndelB and Germany based Webasto. These two companies join forces to bring high quality solutions enhancing comfort in galley equipment for marine applications and to provide excellent customer service in all key boating areas. Our global dealer support network ensures local expertise for all our customers. For more information, please visit our website [www.indelwebastomarine.com](http://www.indelwebastomarine.com).